

SouthernLINC Wireless
iDEN Digital Multi-service Data-capable Phone

i833 Phone User's Guide

NNTN7009B

IMPORTANT NOTICE: PLEASE READ PRIOR TO USING YOUR PHONE

The SIM card provided with this kit is intended for use with the phone provided in this package.

Loss of certain features will result when using a SIM card from one of the following models: *i30sx*, *i35s*, *i50sx*, *i55sr*, *i58s*, *i60c*, *i80s*, *i85s*, *i88s*, *i90c*, *i95c* series, and the *i2000* series.

For more information on SIM card compatibility, go to www.motorola.com/iden/support.

Defects or damage to your Motorola phone that result from the use of non-Motorola branded or certified Accessories, including but not limited to replacement housings and or other peripheral accessories, are excluded from warranty coverage. Please refer to the text of Motorola's Limited One Year warranty located in this user's guide for complete details.

Contents

Getting Started..... 1

Removing the Battery Door.....	3
Locating Your SIM Card.....	3
Battery.....	4
Activating Service.....	7
Powering On and Off.....	7
Enabling Over-the-Air Security.....	8
Finding Your Phone Number and LINC ID.....	8
Phone Basics.....	9
SIM Card Security.....	12
Antenna.....	15
Accessories.....	16
For More Information.....	16

Making Calls..... 17

Phone Calls.....	17
InstantLINC Mobile to Mobile Calls.....	17
Receiving Calls.....	18
Ways to Enter Calls.....	18
Missed Phone Calls.....	21

Using Speakerphone.....	21
Using Mute.....	21
Making Emergency Phone Calls.....	22

Call Alerts.....23

Sending Call Alerts.....	23
Receiving Call Alerts.....	23
Using the Call Alert Queue.....	23

Recent Calls.....25

Calls and Call Alerts.....	25
My Info From Other Phones.....	25
Contact Information From Other Phones.....	26
Viewing the Recent Calls List.....	26
Storing Items to Contacts.....	27
Deleting Items.....	27
Making Calls From the Recent Calls List.....	28

Contacts.....30

Viewing Contacts.....	31
Creating Entries.....	32
Storing Numbers From the Idle Screen.....	33
Editing Entries.....	34

Deleting Entries	34	Group Calls	46
Checking Capacity	34	Joining a Talkgroup	46
Creating Pauses and Waits	34	Making Group Calls	46
International Numbers	35	Receiving Group Calls	46
Accessing Contacts with GSM Phones	35	Turning off Group Calls	46
Call Forwarding.....	36	Memo	48
Forwarding All Calls	36	Ring Tones	49
Turning Off Call Forwarding	36	Setting Your Phone to Vibrate	49
Forwarding Missed Calls	37	Ring and Vibrate	50
Viewing Call Forwarding Settings.....	37	Assigning Ring Tones to Contacts	50
Advanced Calling Features.....	38	Viewing Ring Tone Assignments	50
Call Waiting	38	Downloading More Ring Tones	51
Switching Between Calls	38	Managing Memory	51
Putting a Call on Hold.....	39	Deleting Custom Ring Tones	51
Calling 2 People	39	Entering Text	52
Creating Pauses and Waits While Dialing.....	40	Using Alpha Mode	52
Setting One Touch PTT.....	40	Using Word Mode	52
Setting Flip Actions.....	41	Special Function Keys.....	53
Call Timers	41	Using Numeric Mode.....	54
Using Your Phone as a Modem	42	Using Symbols Mode	54
Making TTY Calls	43		

Messages	55
Message Notifications	55
Message Center	56
Voice Mail Messages	57
Receiving a Message	57
Accessing Voice Mail from the Message Center	57
Sending Unanswered Calls to Voice Mail	57
Text Messages	58
Setting Up.....	58
Receiving a Message	58
Reading from the Message Center	59
Creating and Sending Messages	59
Sorting Messages.....	62
Managing Memory.....	62
My Info	63
Viewing My Info	63
Editing My Info.....	63
Setting Sending Options.....	64

Using LINC View	65
Sending My Info and Contact Information	65
Datebook	68
Viewing Datebook	68
Creating Events.....	69
Editing Events	71
Deleting Events	71
Receiving Reminders	72
Making Calls From Datebook.....	73
Customizing Datebook Setup.....	73
Java Applications	75
Installing Applications.....	75
Running Applications	75
Suspending Applications	75
Resuming Applications.....	76
Ending Applications.....	76
Downloading Applications	76
Deleting Applications.....	76
Managing Memory	77
Shortcuts on the Main Menu	77
Java Applications and GPS Enabled	78

GPS Enabled	81	Profiles	99
IMPORTANT: Things to Keep in Mind	81	Viewing Profiles.....	99
Making an Emergency Call	82	Switching Profiles.....	99
Viewing Your Approximate Location	83	How Changing Settings Affects Profiles.....	99
Enhancing GPS Performance	84	Temporary Profiles.....	100
Setting Privacy Options	86	Creating Profiles.....	101
Using GPS with Map Software	87	Editing Profiles	101
Voice Records.....	90	Deleting Profiles	101
Creating Voice Records	90	Setting Call Filtering	102
Playing Voice Records	90	Shortcuts.....	103
Labeling Voice Records	90	Creating a Shortcut	103
Deleting Voice Records.....	91	Using a Shortcut.....	103
Locking Voice Records.....	91	Editing a Shortcut.....	104
Managing Memory.....	91	Deleting Shortcuts.....	104
Customizing Your Phone	92	Using a Headset	105
Setting the Volume	92	Attaching a Headset.....	105
Setting Your Phone to Vibrate.....	92	Using a Remote PTT Button	105
Changing the Look of Your Phone	92	Understanding Status Messages	106
Airplane Mode — Temporarily		Safety and General Information	109
Turning Off Calls.....	94	RF Operational Characteristics	109
Using Settings	94		

Portable Radio Product Operation and EME Exposure	109
Electromagnetic Interference/Compatibility...	112
Implantable Medical Devices.....	112
Operational Warnings.....	113
Operational Cautions.....	114
Accessory Safety Information.....	115
California Perchlorate Label	117
Hearing Aid Compatibility.....	118
MOTOROLA LIMITED WARRANTY	120
Patent and Trademark Information	124
Index	125

DECLARATION OF CONFORMITY

Per FCC CFR 47 Part 2 Section 2.1077(a)



Responsible Party Name: Motorola, Inc.

Address: 8000 West Sunrise Boulevard
Plantation, FL 33322 USA

Phone Number: 1 (800) 453-0920

Hereby declares that the product:

Product Name: i833

Model Number: H74XAH6RR4AN

Conforms to the following regulations:

FCC Part 15, subpart B, section 15.107(a),
15.107(d) and section 15.109(a)

Class B Digital Device

As a personal computer peripheral, this device complies with Part 15 of the FCC Rules. Operation is subject to the following two conditions: (1) this device may not cause harmful interference, and (2) this device must accept any interference received, including interference that may cause undesired operation.

Note: This equipment has been tested and found to comply with the limits for a Class B digital device, pursuant to part 15 of the FCC Rules. These limits are designed to provide reasonable protection against harmful interference in a residential installation. This equipment generates, uses and can radiate radio frequency energy and, if not installed and used in accordance with the instructions, may cause harmful interference to radio communications. However, there is no guarantee that interference will not occur in a particular installation.

If this equipment does cause harmful interference to radio or television reception, which can be determined by turning the equipment off and on, the user is encouraged to try to correct the interference by one or more of the following measures:

- Reorient or relocate the receiving antenna.
- Increase the separation between the equipment and receiver.
- Connect the equipment into an outlet on a circuit different from that to which the receiver is connected.
- Consult the dealer or an experienced radio/TV technician for help.

Motorola, Inc.
Consumer Advocacy Office
1307 East Algonquin Road
Schaumburg, IL 60196

www.hellomoto.com

1-800-331-6456 (United States)

1-888-390-6456 (TTY/TDD US for hearing
impaired)

1-800-461-4575 (Canada)

Certain mobile phone features are dependent on the capabilities and settings of your service provider's network. Additionally, certain features may not be activated by your service provider, and/or the provider's network settings may limit the feature's functionality. Always contact your service provider about feature availability and functionality. All features, functionality, and other product specifications, as well as the information contained in this user's guide are based upon the latest available information and are believed to be accurate at the time of printing. Motorola reserves the right to change or modify any information or specifications without notice or obligation.

© Motorola, Inc., 2007. MOTOROLA and the Stylized M Logo are registered in the US Patent & Trademark Office. All other product or service

names are the property of their respective owners.

Software Copyright Notice

The Motorola products described in this manual may include copyrighted Motorola and third-party software stored in semiconductor memories or other media. Laws in the United States and other countries preserve for Motorola and third-party software providers certain exclusive rights for copyrighted software, such as the exclusive rights to distribute or reproduce the copyrighted software. Accordingly, any copyrighted software contained in the Motorola products may not be modified, reverse-engineered, distributed, or reproduced in any manner to the extent allowed by law. Furthermore, the purchase of the Motorola products shall not be deemed to grant either directly or by implication, estoppel, or otherwise, any license under the copyrights, patents, or patent applications of Motorola or any third-party software provider, except for the normal, non-exclusive, royalty-free license to use that arises by operation of law in the sale of a product.

Getting Started

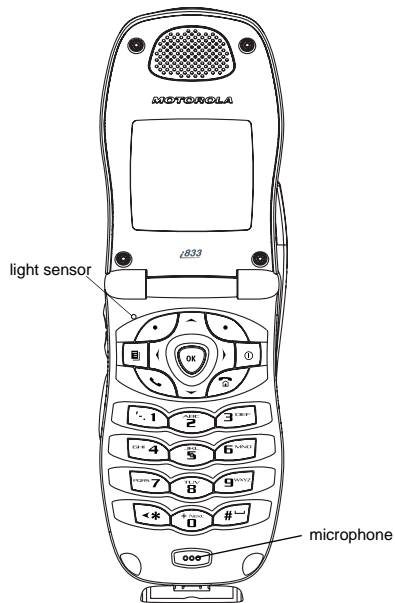
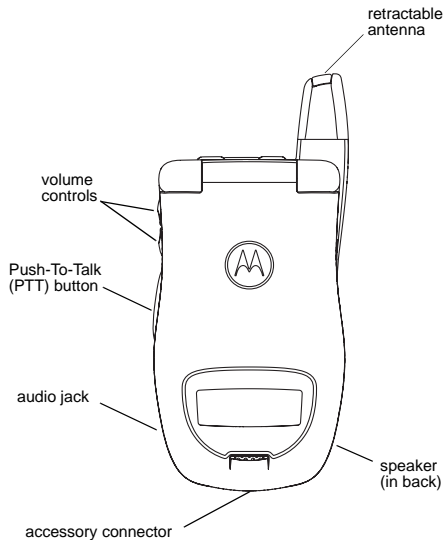

Getting Started



Power button.



Navigation key — press the arrows to scroll through menus and lists.



OK key — selects highlighted item; answers calls.



Menu key — accesses context-sensitive menus.



Option key — selects the option appearing above it on the display.



Send key — places phone calls.



End key — ends phone calls; returns to idle screen.

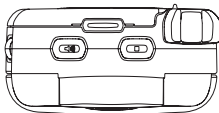

Acts like  when the flip is closed; turns speaker on; used with voice names and voice records.



Acts like  when the flip is closed; accesses recent calls; sends incoming calls to voice mail.

To start using your i833 phone:

- Make sure your SIM card is in place.
- Charge the battery.
- Activate your service.
- Enable over-the-air security if you are prompted to.

Removing the Battery Door

- 1 Make sure the phone is powered off. See “Powering On and Off” on page 7.
- 2 Press the release button and pull the battery door away from the phone.

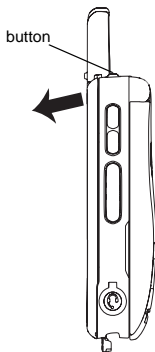

Locating Your SIM Card

Your SIM (Subscriber Identity Module) card is a small piece of plastic located in the SIM card holder in the back of your phone, underneath the battery.

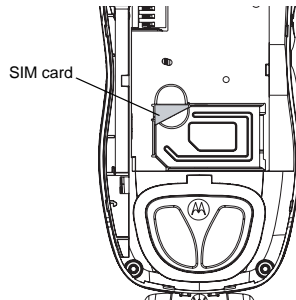

If your SIM card is not in the SIM card holder, it may be in the box your phone came in, attached to a piece of plastic about the size of a credit card. If this is the case, carefully detach your SIM card from the surrounding plastic and insert it as described in “Inserting Your SIM Card” on page 14.

Getting Started

If there is no SIM card in your phone or the box, contact SouthernLINC Wireless at 1-800-406-0151.

Battery

Inserting the Battery

- 1 Remove the battery door.
- 2 Insert the battery into the battery area. Press the battery down to secure it.

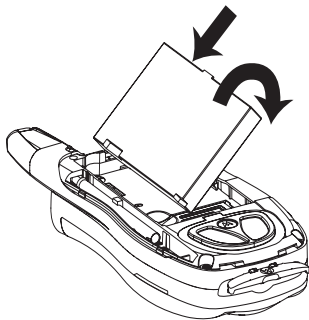

- 3 To replace the battery door, locate the tabs on the battery door and the slots in the phone.

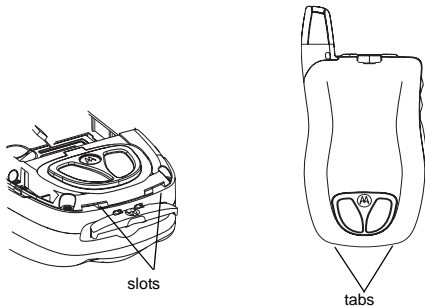

- 4 Place the tabs on the battery door into the slots on the phone.

- 5 Move the top of the battery door into place. Press it over the release button until you hear a click.

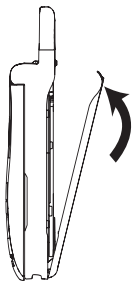

Charging the Battery

Your phone comes with a battery charger.

- 1 Plug the charger into an electrical outlet.

- 2 Open the connector cover.

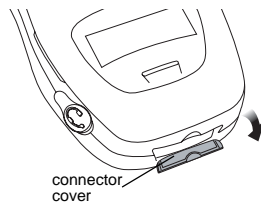

- 3 Plug the other end of the charger into the accessory connector.

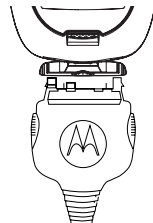

Charger Attached or **Device Attached** appears on the internal display.

Getting Started

Tip: To remove the charger from the accessory connector: Press the buttons on the sides of the plug. Pull the plug straight out.

- 4 If you have purchased optional batteries or chargers, see “Charging Times”.

Charging Times

See your battery and charger to determine the appropriate charging time.

Battery	Charger	
	Rapid	Standard
Slim SC	2 hours	3 hours

For best results, charge the batteries within the temperature range of 50°F to 104°F (10°C to 40°C).

Prolonged charging is not recommended.

Removing the Battery

- 1 With the phone powered off, remove the battery door.
- 2 Remove the battery by lifting it out from the side.

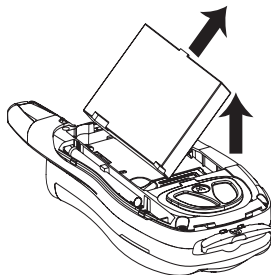

Battery Use and Maintenance

- The Motorola iDEN Approved Lithium Ion chargers provide optimum performance. Other chargers may not fully charge the iDEN Lithium Ion battery or may yield a reduced number of lifetime charge cycles.
- Extreme temperatures degrade battery performance. Do not store the battery where temperatures exceed 140°F (60°C) or fall below 4°F (-20°C).

- Lithium Ion batteries have a self discharge rate and without use, lose about 1% of their charge per day.
- The battery capacity is degraded if the battery is stored for long periods while fully charged. If long term storage is required, store at half capacity.

Activating Service

The first time you power on your phone, you must be in your local calling area. This activates your service.

Powering On and Off

The first time you power your phone on, a screen may appear asking you to update your browser information. This means you must enable security.

To power your phone on:

- 1 Open the flip.
- 2 Press .

Note: When powering on, if you press  for more than 5 seconds, you will turn on Airplane mode. See “Airplane Mode — Temporarily Turning Off Calls” on page 94.

To power your phone off:

- 1 Open the flip.
- 2 Press and hold .

When You Power On For the First Time

If the **Enter SIM PIN Code** screen appears, enter your SIM PIN. See “Entering the PIN” on page 12. Press  under **Ok**.

When you receive your phone, the SIM PIN is 0000. Change your PIN to prevent fraudulent use of the SIM card (see “Changing the PIN” on page 12).

Getting Started



As your phone connects to the network, you will see a welcome message and a connecting message. When the idle screen appears, the phone is ready to use.





Enabling Over-the-Air Security

If you are set up to receive over-the-air programming from SouthernLINC Wireless, you must enable security the first time you power on your phone or within 10 days of first activation of your phone:



- 1 When you power on your phone for the first time, after the idle screen appears, you will be prompted to select **Ok** to update your browser information.

Note: If you press  under **Later**, you will be prompted to enable security each time you power on your phone until you press  under **Ok**.

- 2 Press  under **Ok**.
- 3 You are prompted to enable security. Press  under **Yes**. A series of screens appears. If you subscribe to the appropriate SouthernLINC Wireless plan, your home page appears.
- 4 Press  to return to the idle screen.

Finding Your Phone Number and LINC ID

My Info lets you view your phone number, LINC ID, and other phone information:

- 1 Press  to access the main menu.
- 2 Scroll to **My Info**.
- 3 Press .
- 4 Scroll to see your information.
 - **Line 1** and **Line 2** are your phone numbers.
 - **LINC ID** is the number that others use to contact you using InstantLINC Mobile to Mobile calls. It is filled in when you receive your first InstantLINC Mobile to Mobile call.

See “My Info” on page 63 for more information about this feature.

Phone Basics

Any time your phone is powered on, the display provides you with information and options.

The external display shows a shortened version of the internal display. To see more information, open the flip.

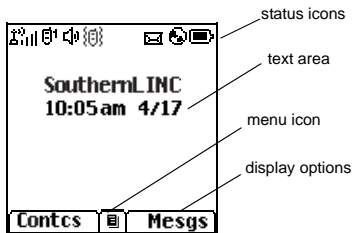

The screen shown is the idle screen. The idle screen appears when your phone is on, but not engaged in any activity.

Text Area

This area displays menus, messages, names, phone numbers, and other information.

Display Options

Two display options appear at the bottom of most screens. You select a display option by pressing the option key below it.

Menus and Lists

Your phone's features are arranged in menus, submenus, and lists.

To access the items in a menu or list, scroll using the navigation key at the top of your keypad. This key lets you scroll up, down, left, or right. Holding down the appropriate part of the navigation key speeds up scrolling.

In this guide, this symbol > tells you to select a menu or list item. For example, **Settings > Security** means:

- 1 Scroll to **Settings** on the main menu.
- 2 Press to see the **Settings** screen.
- 3 Scroll to **Security**.
- 4 Press to see the **Security** screen.

OK Key



Pressing :

- Selects the highlighted menu item or list item
- Sets options

Getting Started





- Confirms actions
- Places and answer calls











Menu Key

Many features provide context-sensitive menus that let you access related features and actions. This icon  appears any time a context-sensitive menu is available. Press  to access the menu.

Main Menu

All your phone's features can be accessed through the main menu. You can set the main menu to appear as a list or as large icons.

	Browser	Browse the Web.
	Java Apps	Java applications on your phone. See page 75.
	Settings	Customize your phone. See page 92.
	VoiceRecord	Record and play audio messages. See page 90.
	Contacts	Create, view, store, and edit Contacts. See page 30.

	Messages	Access messages. See page 55.
	Call Forward	Set call forwarding options. See page 36.
	Datebook	Schedule appointments. See page 68.
	Memo	Store a number to access later. See page 48.
	Call Timers	Phone usage information. See page 41.
	Recent Calls	Lists recent calls. See page 25.
	Shortcuts	Create shortcuts to screens. See page 103.
	My Info	View personal phone information, including phone number and LINC ID. See page 8.
	Profiles	Groups of settings you apply together. See page 99.
	Call Alert	Lists call alerts. See page 23.

 **GPS** Find your approximate geographical location. See page 81.

 **Ring Tones** Assign ring tones and turn ringer off. See page 49.

Quick Access to Main Menu Items

Each arrow in the navigation key and  can be used to access a main menu item from the idle screen. Each of these keys is assigned to a main menu item when you receive your phone. To assign different main menu items, see “Personalize Features” on page 96.

Status Icons

Status icons appear at the top of the display. Some appear at all times. Others appear only when your phone is engaged in certain activities or when you have activated certain features.

 **Battery Strength** — A fuller battery indicates a greater charge.

 **Signal Strength** — More bars next to the antenna indicate a stronger signal.

 **Phone In Use** — Your phone is active on a phone call.

 **InstantLINC Mobile to Mobile In Use** — Your phone is active on an InstantLINC Mobile to Mobile call.

 **Talkgroup In Use** — Your phone is active on a group call.

 **Active Phone Line** — 1 indicates phone line 1 is ready to make calls; 2 indicates phone line 2 is ready to make calls.

 **Call Forward** — Your phone is set to forward calls. See page 36.

 **Ringer Off** — Your phone is set not to ring. See page 49.

 **Messages** — You have one or more messages. See page 55.

 **Internet** — You are ready to browse the internet.

 **Airplane Mode** — Your phone is set to airplane mode. See page 94.

Getting Started



Packet Data — You are ready to transfer packet data or are transferring packet data. See page 42.



TTY — You are ready to use your phone to make calls using a teletypewriter device. See page 43.



Roaming — You are using your phone outside of the SouthernLINC Wireless network.

SIM Card Security

Your SIM card protects your personal information. The SIM card stores all your Contacts information. Since this information is stored on your SIM card, not in your phone, you can remove the information by removing your SIM card.

Note: Except for making emergency calls, your phone will not function without the SIM card.

To prevent unauthorized use of your phone, your SIM card may be protected by a PIN that you enter each time the phone is powered on. You can change the PIN or turn off the requirement that it be entered.

Entering the PIN



You may be required to enter a SIM PIN when you first use your phone.

When you receive your phone, the SIM PIN is 0000. Change your PIN to prevent fraudulent use of the SIM card.

Important: If you enter your PIN incorrectly 3 times, your SIM card is blocked. To unblock your SIM card, you must contact SouthernLINC Wireless at 1-800-406-0151. See “Unblocking the PIN” on page 13.

- 1 When the **Enter SIM PIN Code** screen appears, enter your SIM PIN. An asterisk appears for each character entered.
- 2 Press  under **Ok**.

Changing the PIN

- 1 From the main menu, select **Settings > Security > Change Password > SIM PIN**.
- 2 At the **Enter Old SIM PIN** screen, enter the current SIM PIN.
- 3 Press  under **Ok**.
- 4 At the **Enter New SIM PIN** screen, enter the new 4- to 8-digit SIM PIN.
- 5 Press  under **Ok**.

- 6 At the **Re-enter New SIM PIN** screen, re-enter the new SIM PIN to confirm.
- 7 Press  under **Ok**.

Turning the PIN Requirement On and Off

When the SIM PIN requirement is on, you are prompted to enter your PIN each time you turn on your phone.

Note: If a SIM PIN is required, your phone will not function until the SIM PIN is entered, except for making emergency calls.

When the PIN requirement is off, your phone can be used without entering a PIN.

Important: When the SIM PIN requirement is off, the personal data on your SIM card is not protected. Anyone can use your phone and access your personal data.





- 1 From the main menu, select **Settings > Security > SIM PIN**.
- 2 Select **On** or **Off**.
- 3 Enter the current SIM PIN.
- 4 Press  under **Ok**.

Unblocking the PIN

If you enter your PIN incorrectly 3 times, your SIM card is blocked. To unblock your SIM card, you must contact SouthernLINC Wireless at 1-800-406-0151 to get a PIN Unblock Code (PUK).

Important: If you unsuccessfully enter the PUK code 10 times, your SIM card is permanently blocked and must be replaced. If this happens, all data is lost. You will get a message to contact SouthernLINC Wireless. Except for making emergency calls, your phone will not function with a blocked SIM card.

To unblock the PIN:

- 1 Press    .
- 2 At your SouthernLINC Wireless representative's request, provide the information needed to give you a PUK code.
- 3 Select **Unblock PIN**.
- 4 Enter the PUK code.
- 5 Enter a new 4- to 8-digit SIM PIN.
- 6 Re-enter your SIM PIN.

If you entered the codes properly, **SIM Unlocked** appears on the display.

Getting Started

Inserting and Removing Your SIM Card

Important: Do not touch the gold-colored areas of your SIM card.

Switching SIM Cards

Moving your SIM card from one phone to another moves all your Contacts information, but erases other information. If you remove your SIM card and use it with another phone, or use another SIM card with your phone, the following information is erased:

- The recent calls list
- Call forwarding settings
- Net alerts
- Text Message drafts, outbox messages, and customized quick notes
- Information stored in Memo
- 3 most recent GPS Enabled locations
- Voice records
- Voice names
- Datebook events
- Options set using the Personalize menu

Inserting Your SIM Card

- 1 With your phone powered off, remove the battery door and battery.
- 2 Open the SIM card holder.

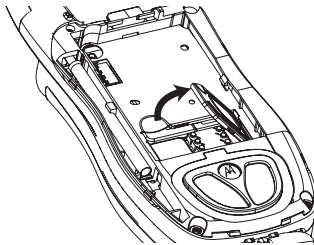

- 3 Carefully slide your SIM card into the SIM card holder.

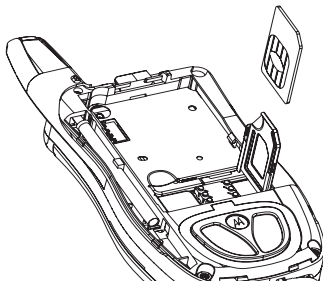

- 4 Close the SIM card holder.

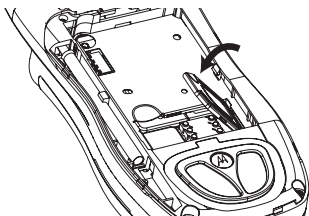

- 5 Lock the SIM card holder: While holding the bottom of the SIM card holder in place with one finger, gently press the top of the holder until you hear the holder click into place.

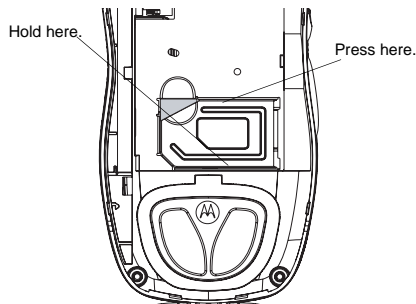

Note: Protect your SIM card as you would any delicate object. Store it carefully.

Antenna

The retractable antenna on your i833 phone is designed to be extended during calls and is essential to attain the hearing aid compatibility rating on applicable models.

Getting Started

To extend the antenna, pull gently on the rounded tip until the antenna is fully extended and clicks into position.

When finished with a call, retract the antenna by pushing gently on the rounded tip until the antenna clicks into place.

To optimize your phone's performance, extend the antenna when you make or receive a call, and avoid touching the antenna with any body part.

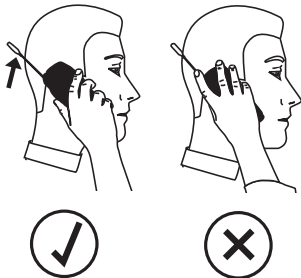

Important: Failure to fully extend or retract the antenna until the antenna clicks into place causes severely degraded performance, which may result in missed calls, dropped calls, or garbled audio.

Accessories

To order accessories, log on to the SouthernLINC Wireless website at www.southernlinc.com/store or contact your SouthernLINC Wireless representative.

For More Information

If you have questions about your i833 phone, contact your sales representative or SouthernLINC Wireless at 1-800-406-0151.

Making Calls

Your i833 phone makes two types of calls: digital cellular phone calls and InstantLINC Mobile to Mobile calls. With InstantLINC Mobile to Mobile calls, you use your phone as a long-range, digital walkie-talkie.

Phone Calls

With the Flip Open

1 Enter the number you want to call.

2 To place the call:

Press . **-or-**

If you entered the number from the idle screen, press .

3 To end the call:

Press . **-or-**

Close the flip.

To end a call by closing the flip, you must have the Flip to End feature turned on. See “Setting Flip Actions” on page 41.

With the Flip Closed

1 Select the number you want to call from the recent calls list and press  (see “From the Recent Calls List” on page 19). **-or-**

Use a voice name to select the number and place the call (see “Using a Voice Name” on page 20).

2 To end the call, press .

InstantLINC Mobile to Mobile Calls

1 If the flip is open, enter the LINC ID you want to call. **-or-**

If the flip is closed, select the number as you would when making a phone call.

2 Press and hold the PTT button on the side of your phone. Begin talking after your phone emits a chirping sound.

3 Release the PTT button to listen.

Tip: To let someone know you want to talk to him or her on an InstantLINC Mobile to Mobile call, send a call alert. See “Call Alerts” on page 23.

Making Calls

Receiving Calls

Phone Calls

When you receive a phone call, your phone rings, vibrates, or lights up its backlight.

Answering

If the flip is closed, press . **-or-**

Open the flip. **-or-**

Press . **-or-**

Press . **-or-**

Press  under **Yes**. **-or-**

Press any number key.

To answer a call by opening the flip, you must have the Flip to Ans feature turned on (see “Setting Flip Actions” on page 41). To answer a call by pressing any number key, you must have the Any Key Ans feature turned on (see “Customizing Your Phone” on page 92).

Sending to Voice Mail

If the flip is closed, press . **-or-**

Press . **-or-**

Press  under **No**.

Ending

If the flip is closed, press . **-or-**

Press . **-or-**

Close the flip.

Ways to Enter Calls



- Use the numbers on the keypad
- Select the number from the recent calls list
- Select the number from Contacts
- Select a number stored in Datebook
- Redial the last phone number called
- Say a voice name into your phone
- Use Speed Dial or Turbo Dial®
- Use One Touch PTT to make an InstantLINC Mobile to Mobile call
- Use a TTY device — see “Making TTY Calls” on page 43

From the Keypad

To enter the number you want to call, press the numbers on the keypad.

If you make a mistake:

- To clear a digit, press  under **Delete**.

- To clear all digits, press and hold  under **Delete**.
- To insert or delete a digit anywhere in the string of digits you have entered, scroll left or right.
- To cancel, press .

From the Recent Calls List

The recent calls list stores the last 20 calls you made or received.

With the Flip Open

- 1 From the main menu, select **Recent Calls**.
- 2 Scroll to the name or number you want to call.

With the Flip Closed

- 1 Press  to display the most recent call.
- 2 To view the rest of the recent calls list, press the volume controls.

You can call the number displayed by pressing  on the top of your phone.

From Contacts

If you have numbers stored in Contacts, you can use these numbers to make calls. For information on entering numbers into Contacts, see “Creating Entries” on page 32.

- 1 From the main menu, select **Contacts**.

- 2 Scroll to the name or number you want to call.

Tip: To find Contacts entries faster, use the keypad to enter the first letter of the name.

- 3 Place the call now. **-or-**

Scroll left or right to display the Contacts type for the number you want to call.

If you are making an InstantLINC Mobile to Mobile call, your phone places the call to the LINC ID stored in the Contacts entry, even if the InstantLINC Mobile to Mobile icon is not displayed.

If you are making a phone call:

- Your phone places the call to the phone number assigned to the Contacts type displayed.
- If the Contacts type displayed is not a phone number, your phone places the call to the phone number stored in the Contacts entry.
- If the Contacts type displayed is not a phone number and you have more than one phone number stored in the Contacts entry, your phone prompts you to select the phone number you want to place the call to.

Making Calls

From Datebook

If you have numbers stored as part of events in Datebook, you can use these numbers to make calls. For information on storing events in Datebook, see “Datebook” on page 68.

- 1 From the main menu, select **Datebook**.
- 2 Select the day of the event containing the number you want to call.
- 3 Highlight or select the event containing the number you want to call.

For details, see “Making Calls From Datebook” on page 73.

Redialing the Last Number

Press and hold  to place a call to the last phone number you called.

Using a Voice Name

If you have created a voice name in Contacts for the number you want to call, say the voice name into your phone to enter the number. See page 31 for information on voice names.



You can use a voice name to enter a number.

You can use a voice name to enter a number with the flip open or closed.

- 1 Press and hold  until a prompt appears telling you to say the voice name.
- 2 Speaking into the microphone, say the voice name assigned to the number you want to call.

Your phone plays the name back to you.

If you are making a phone call, the call is placed automatically.



Tip: To stop a phone call from being completed, press  if the flip is closed or press .

If you are making an InstantLINC Mobile to Mobile call, press and hold the PTT button to place the call.

Using Speed Dial and Turbo Dial®

Each phone number stored in Contacts is assigned a Speed Dial number which you can use to call that number.

Speed Dial

- 1 From the idle screen, use the keypad to enter the Speed Dial number assigned to the phone number you want to call.
- 2 Press .
- 3 Press .

Turbo Dial

From the idle screen, press and hold the Speed Dial number (1 through 9) assigned to the phone number you want to call.

Using One Touch PTT

One Touch PTT sets your phone to call the most recent LINC ID on the recent calls list, or a LINC ID you choose, every time you press the PTT button. See “Setting One Touch PTT” on page 40.

Missed Phone Calls

When you miss a call, this icon  and the number of phone calls you have missed appear briefly.

With the Flip Open

If you want to dismiss the missed call message, press  under **Back**. -or-

If you want to view the missed call on the recent calls list, press  under **View**.

With the Flip Closed

If you want to dismiss the missed call message, press .

If you want to view the missed call on the recent calls list, press  twice.

Using Speakerphone

Turning on speakerphone makes incoming sound come out of the phone's speaker instead of the earpiece. Speakerphone is available whenever you are on an active phone call.

With the Flip Open

To turn speakerphone on or off:

Press  under **Spkr.** -or-

Press .

With the Flip Closed

When you make a call with the flip closed, speakerphone is always on.

Opening the flip turns speakerphone off.

Using Mute

Muting calls lets you listen to incoming sound without transmitting sound. Mute is available whenever you are on an active call.

To turn mute on:

Press  under **Mute**.

While mute is on, **Unmute** appears as a display option.

Making Calls

To turn mute off:

Press  under **Unmute**.

Making Emergency Phone Calls

Your phone supports emergency calling. Emergency phone calls can be made even when your SIM card is blocked or not in your phone.

Dial 911 to be connected to an emergency response center. If you are on an active call, you must end it before calling 911.

When you make an emergency call, your phone's GPS Enabled feature can help emergency service personnel find you, if you are in a location where your phone's GPS antenna has established a clear view of the open sky and your local emergency response center has the equipment to process location information. See "GPS Enabled" on page 81, and particularly "IMPORTANT: Things to Keep in Mind" on page 81 and "Making an Emergency Call" on page 82, for more information on the limitations of this feature. Because of the limitations of this feature, always provide your best knowledge of your location to the emergency response center when you make an emergency call.

Important: Emergency calls cannot be placed while the keypad is locked.

Important: If you have not registered on the network, emergency calls cannot be placed while your SIM card is in your phone.

Call Alerts

Sending a call alert lets the recipient know you want to talk to him or her on an InstantLINC Mobile to Mobile call.

When you send a call alert, the recipient's phone emits a series of beeps, or vibrates, and displays your name or LINC ID.

The recipient can:

- Answer — begin an InstantLINC Mobile to Mobile call with the sender
- Queue — store the call alert to the call alert queue, which is a list of call alerts
- Clear — dismiss and delete the call alert

Sending Call Alerts

- 1 Enter the LINC ID you want to send to, as you would when making an InstantLINC Mobile to Mobile call.
- 2 Press  under **Alert**. **Ready to Alert** appears on the display.
- 3 Press the PTT button until **Alert Successful** appears on the display.

Note: If the alert is not successful, this may mean the person you are trying to reach is on a call or has the phone turned off.

Receiving Call Alerts

When you receive a call alert, you must answer, queue, or clear it. You cannot receive phone calls or InstantLINC Mobile to Mobile calls until you do.

To answer a call alert:

Press the PTT button to make an InstantLINC Mobile to Mobile call to the sender.

To queue a call alert:

Press  under **Queue**.

To clear a call alert:

Press . **-or-**

Press  under **Clear**. **-or-**

If the flip is closed, press .

Note: The recent calls list also stores call alerts you have received. They appear as InstantLINC Mobile to Mobile calls. Call alerts remain in your recent calls list until you delete them or until they reach the end of the list.

Using the Call Alert Queue

When you queue a call alert, it remains in the call alert queue until you make an InstantLINC Mobile to Mobile call to the sender or delete it.

Call Alerts

Viewing Call Alerts

- 1 From the main menu, select **Call Alert**.
- 2 Scroll through the list.

Viewing Date and Time

To view the date and time a call alert was received:

- 1 From the main menu, select **Call Alert**.
- 2 Select the call alert you want information on.

Responding to Call Alerts in the Queue

After you queue a call alert, you can respond to it by making an InstantLINC Mobile to Mobile call to the sender or sending a call alert to the sender.

Making an InstantLINC Mobile to Mobile call to the Sender

- 1 From the main menu, select **Call Alert**.
- 2 Scroll to the call alert you want to respond to.
- 3 Press the PTT button to begin the call.

This removes the call alert from the queue.



Sending a Call Alert to the Sender

- 1 From the main menu, select **Call Alert**.
- 2 Scroll to the call alert you want to respond to.



- 3 Press  under **Alert**. **Ready to Alert** appears on the display.
- 4 Press the PTT button until **Alert Successful** appears on the display.

Deleting Call Alerts

To delete a call alert from the queue:

- 1 From the call alert queue, scroll to the call alert you want to delete.
- 2 Press .
- 3 Select **Delete**.
- 4 Press  or press  under **Yes** to confirm.

To delete all call alerts from the queue:

- 1 From the call alert queue, press .
- 2 From the call alert menu, select **Delete All**.
- 3 Press  or press  under **Yes** to confirm.

Sorting Call Alerts

Tip: You must have at least one call alert in the queue to access this feature.

To sort call alerts by the order they were received:

- 1 From the main menu, select **Call Alert**.
- 2 Press .
- 3 Select **Sort By**.
- 4 Select **First on Top** or **Last on Top**.

Recent Calls

The recent calls list stores information associated with calls you have made and received and call alerts you have received. The recent calls list also stores My Info and contact information sent to you from other phones.

The recent calls list stores up to 20 items.

Calls and Call Alerts

The recent calls list stores the numbers of up to 20 of the most recent calls you have made and received.



If the number of a recent call is stored in Contacts, the following information appears:

- The name assigned to the number
- The Contacts type icon associated with the number. If the Contacts entry containing the number has more than one number or address stored,  surrounds the Contacts type icon. For information on Contacts types, see page 30.

The LINC ID Contacts type icon appears when you receive an InstantLINC Mobile to Mobile call or call alert, even if the number is not stored in Contacts.

Call alerts you have received appear as InstantLINC Mobile to Mobile calls. Like all items in the recent calls list, they remain listed until you delete them or until they reach the end of the list.

For phone calls, an additional icon appears giving information about the call:

-  A call you made.
-  A call you received.
-  A missed call. Missed calls appear on the recent calls list only if you have Caller ID.

When you select a call to view its details, you see information such as the name associated with the call, the number, date, time, and duration of the call.

My Info From Other Phones

The recent calls list stores My Info from other phones. See “Sending My Info and Contact Information” on page 65.

This icon  appears with My Info from other phones on the recent calls list, along with the LINC ID of the person who sent the information.

Recent Calls

When you select My Info from other phones to view its details, you see all the information sent.

If you receive My Info from the same phone more than once, only the most recently sent version appears in the recent calls list.

Contact Information From Other Phones

The recent calls list stores contact information sent from other phones. This information comes from the other phone's Contacts list or recent calls list. See "Sending My Info and Contact Information" on page 65.

This icon  appears with contact information on the recent calls list.

Contact information in the recent calls list displays:

- The name contained in the contact information
- The Contacts type icon associated with the number or address contained in the contact information. If the item contains more than one number or address stored,  surrounds the Contacts type icon.

The name or LINC ID of the person who sent the contact information appears as a separate item on the recent calls list, above the information sent. If one person sends you more than one item of contact information, all the items appear below the person's name or LINC ID.

When you select contact information to view its details, you see the name or LINC ID of the person who sent the information and all the information in the item.

If you receive contact information with the same name from the same phone more than once, only the most recently sent version appears in the recent calls list.

Viewing the Recent Calls List

With the Flip Open



- 1 From the main menu, select **Recent Calls**.
- 2 Scroll through the list.

To view the details of an item on the list:

From the recent calls list, select the item you want information on.

Tip: To view the details of more items, keep scrolling.

With the Flip Closed

- 1 Press .
- 2 If you want to view the rest of the recent calls list, press the volume controls.
- 3 Press  to dismiss the recent calls list.

Storing Items to Contacts

- 1 From the recent calls list, scroll to or select the item you want to store.
- 2 Press  under **Store**. -or-

If **Store** is not one of your options: Press .
Select **Store** or **Update Contacts**.

Tip: If the item you want to store is a call, **Store** does not appear if the number is already stored in Contacts.

- 3 To store the item as a new entry, select [**New Contact**]. -or-
To store the number to an existing entry, select the entry.

Note: Storing My Info or contact information from another phone to a Contacts entry that has a name assigned to it does not change the name of the Contacts entry.

- 4 If the item you want to store is a call, you must assign a Contacts type to the number:

With the Contacts type field highlighted, scroll left or right to display the Contacts type you want to assign the number.

- 5 If you want to add more information to the entry, follow the applicable instructions in “Creating Entries” on page 32.
- 6 Press  under **Done**.

Deleting Items



To delete an item from the recent calls list:

- 1 From the recent calls list, scroll to or select the item you want to delete.
- 2 Press  under **Delete**. -or-

If **Delete** is not one of your options: Press .
Select **Delete**.

- 3 Press  or press  under **Yes** to confirm.

To delete all items on the recent calls list:

- 1 From the recent calls list, press .
- 2 Select **Delete All**.
- 3 Press  or press  under **Yes** to confirm.

Making Calls From the Recent Calls List

With the Flip Open

- 1 From the main menu, select **Recent Calls**.
- 2 Scroll to the item containing the number you want to call.
 - If you scroll to a call, you can make a call to the number that made the call. If the number is stored in Contacts, you can make a call to any of the numbers stored with it.
 - If you scroll to My Info from another phone, you can make a call to the LINC ID of the phone that sent the information.
 - If you scroll to contact information from another phone, you can make a call to any of the numbers in the contact information.
- 3 To place the call now, go to step 4. **-or-**
Scroll left or right to display the Contacts type for the number you want to call.
- 4 To make a phone call, press . **-or-**
To make an InstantLINC Mobile to Mobile call, press the PTT button.

You can also make calls while viewing the details of an item on the recent calls list:

- 1 From the recent calls list, select the item containing the number you want to call.
 - If you select a call or contact information from another phone, you can make a call to the number shown first on the details screen.
 - If you scroll to My Info from another phone, you can make a call to the LINC ID of the phone that sent the information.
- 2 To make a phone call, press . **-or-**
To make an InstantLINC Mobile to Mobile call, press the PTT button.

With the Flip Closed

- 1 Press  to display the most recent call.
- 2 Press the volume controls to scroll to the name or number you want to call.
 - If you scroll to a call, you can make a call to the number that made the call.
 - If you scroll to My Info from another phone, you can make a call to the LINC ID of the phone that sent the information.
 - If you scroll to contact information from another phone, you can make a call to the number currently displayed.

Making Calls From the Recent Calls List

- 3** To make a phone call, press  on the top of your phone. **-or-**
To make an InstantLINC Mobile to Mobile call, press the PTT button.

Contacts











Contacts stores up to 600 numbers or addresses. Each Contacts entry can store several numbers or addresses.

Information stored in Contacts is saved on your SIM card.

A Contacts entry contains:

- A name — A name is required if you are storing more than one number or address to the entry; otherwise, it is optional. Typically, this is the name of the person whose contact information is stored in the entry.
- A ring tone — You can assign a ring tone to each entry. This is the sound your phone makes when you receive phone calls or call alerts from any of the numbers stored in the entry.

- A Contacts type — Each number or address stored must be assigned a Contacts type:

	Mobile	phone number
	LINC ID	LINC ID number
	Work1	phone number
	Work2	phone number
	Home	phone number
	Email	email address
	Fax	phone number
	Pager	phone number
	Talkgroup	Talkgroup number
	IP	IP address
	Other	phone number

- A number or address — Each Contacts entry must contain a number or address. This may be any type of phone number, LINC ID number, Talkgroup number, email address, or IP address.

Note: You can store numbers up to 64 digits long, but every 20 digits must be separated by a pause or wait. See “Creating Pauses and Waits” on page 34.

- A Speed Dial number — When you store a phone number, it is assigned a Speed Dial number. You can accept the default Speed Dial number or change it.
- A voice name — If you create a voice name for a number, you can then dial that number by saying the voice name into your phone. This icon  appears to the left of the Contacts type icon if a voice name is assigned.



Viewing Contacts

To access Contacts:

From the main menu, select **Contacts**. -or-

If you are on a call: Press . Select **Contacts**.

To view entries:

- 1 From the Contacts list, scroll to the entry you want to view.
- 2 If an entry has more than one number or address stored,  surrounds the Contacts type icon. Scroll left or right to view the icon for each number stored in the entry.
- 3 Press  to view the entry.

- 4 Scroll to view the other numbers and addresses stored for the entry.

Tip: To view more entries, continue scrolling.

Searching for a Name

To search for a name in Contacts:

- 1 From the Contacts list, press  under **Search**.
-or-

If **Search** is not one of your options: Press . Select **Search**.

- 2 Enter the name you want to see.
- 3 Press .

Your phone finds the name you entered or the nearest match.

Showing Only LINC IDs and Talkgroups

To set Contacts to show only entries that contain LINC IDs, and Talkgroups:

- 1 From the Contacts list, press .
- 2 Select **Filter**.
- 3 Set this option to **Show Prvt/Grp**.

To set Contacts to show all entries:

- 1 From the Contacts list, press .

Contacts

- 2 Select **Filter**.
- 3 Set this option to **Show All**.



Creating Entries

A number or address and a Contacts type are required for all Contacts entries. Other information is optional. You may enter the information in any order by scrolling through the entry details.



After you have entered the number or address, Contacts type, and any other information you want, you can press  under **Done** to save the entry to Contacts.

To cancel a Contacts entry at any time press,  to return to the idle screen.

To create a Contacts entry:

- 1 To access the entry details screen:
Select **Contacts > [New Contact]**. -or-
From the Contacts list, press . Select **New Contact**.
- 2 If you want to assign a name to the entry:
Select **Name**.
Enter the name. When you are finished, press .

Tip: Press  under **Browse** to select a name already in Contacts.

- 3 If you want to assign a ring tone to the name:
Select **Ringer**.
Select the ring tone you want to assign.
- 4 To assign a Contacts type to the number or address being stored:
Select the Contacts type field.
Select the Contacts type you want to assign.
- 5 To store a number or address:
Select the **#** field (or **ID** for an email address, or **IP** for an IP address).
Enter the number or address. For phone numbers, use the 10-digit format. For email addresses, see “Entering Text” on page 52.
Tip: Press  under **Browse** to select a number or address from Contacts, the recent calls list, or Memo.
When you are finished, press .
- 6 If you want to assign more options to the number, select **[Options]**. See “Assigning Options” on page 33.

Storing Numbers From the Idle Screen

- 7 If you want to add more numbers or addresses to the entry:
Scroll past the information you already entered.
Enter the additional information for the entry using step 2 through step 6. You must assign a name to the entry, if you have not already.
- 8 Press  under **Done**.

Assigning Options

- 1 If you have not already, select **[Options]**.
- 2 The default Speed Dial number assigned to a phone number is displayed in the **Speed #** field. This is always the next available Speed Dial location.

If you want to assign the phone number to a different Speed Dial location:

With the **Speed #** field highlighted, press .

Press  under **Delete** to delete the current Speed Dial number.



Enter the new Speed Dial number using the keypad.

When you are finished, press .

- 3 If you want to create a voice name for a phone number, select **Voice Name**.
As directed by the screen prompts, say and repeat the name you want to assign to the number. Speak clearly into the microphone.
- 4 When you are finished, press  under **Back**.

Storing Numbers From the Idle Screen

To store numbers to Contacts from the idle screen:

- 1 Use the keypad to enter the number you want to store.
- 2 Press .
- 3 Select **Store Number**.
- 4 To store the number as a new entry, select **[New Contact]**. -or-
To store the number to an existing entry, select the entry.
- 5 With the Contacts type field highlighted, scroll left or right to display the Contacts type you want to assign the number.
- 6 Press  under **Done**.

Contacts

Editing Entries

- 1 From the Contacts list, scroll to the entry you want to edit.
- 2 Press  under **Edit**. -or-



If **Edit** is not one of your options: Press .
Select **Edit**.

The entry details screen displays.

- 3 Follow the applicable instructions in “Creating Entries” on page 32 to edit the various fields.

Deleting Entries

Delete an Entry

- 1 From the Contacts list, scroll to the entry you want to delete.
- 2 Press .
- 3 To delete the entire entry, select **Delete Contact**.
- 4 Press  or press  under **Yes** to confirm.

Delete a Number or Address

- 1 From the Contacts list, scroll to the entry that contains the number or address you want to delete.

- 2 Scroll left or right to display the Contacts type for the number you want to delete.

- 3 Press .

- 4 Select **Delete Number**.

- 5 Press  or press  under **Yes** to confirm.

Note: If an entry contains only one number or address, deleting the number or address deletes the entry.

Checking Capacity

To see how many numbers are stored in Contacts:

- 1 From the Contacts list, press .
- 2 Select **Capacity**.

Creating Pauses and Waits

When storing a number, you can program your phone to pause or wait between digits while dialing. A pause makes your phone pause for 3 seconds before dialing further. A wait makes your phone wait for your response before dialing further.

This feature is useful when using voice mail or other automated phone systems that require you to dial a phone number and then enter an access number.

To program a pause:

Press and hold  until the letter P appears.
The P represents a 3-second pause.

If you store 17035551235P1234, when you select this number and make a call, your phone dials the first 11 digits, pauses for 3 seconds, then dials the last 4 digits.

If you want a pause longer than 3 seconds, press and hold  more than once. Each P represents a 3-second pause.

To program a wait:

Press and hold  until the letter W appears.
The W means your phone waits before dialing further.

If you store 17035551235W1234, when you select this number and make a call, your phone dials the first 11 digits and then waits. A message appears asking if you want to send the rest of the digits. Press  under **Yes** to dial the last 4 digits.

Tip: You can create pauses and waits while dialing a number from the keypad. See “Creating Pauses and Waits While Dialing” on page 40.

International Numbers

For more information, contact your SouthernLINC Wireless sales representative.

Accessing Contacts with GSM Phones

If you plan to use the information stored in Contacts with an *i2000*, *i2000plus*, or any other GSM phone, download iDEN Phonebook Manager.

Go to idenphones.motorola.com/iden/support for more information.







You can use iDEN Phonebook Manager to make the Contacts information saved to your *i833* phone's SIM card accessible in this type of phone.

Call Forwarding

Call forwarding sends calls to the phone numbers you specify. You can forward all calls to one number or forward missed calls to different numbers depending on the reason you missed the call. You can forward phone lines 1 and 2 independently.

Forwarding All Calls

When you set your phone to forward all calls, an icon appears in the top row of the display:



-  Phone line 1 is active; calls to phone line 1 are being forwarded.
-  Phone line 1 is active; calls to phone line 2 are being forwarded.
-  Phone line 1 is active; calls to phone lines 1 and 2 are being forwarded.
-  Phone line 2 is active; calls to phone line 1 are being forwarded.
-  Phone line 2 is active; calls to phone line 2 are being forwarded.
-  Phone line 2 is active; calls to phone lines 1 and 2 are being forwarded.



To forward all calls:

- 1 From the main menu, select **Call Forward > Forward > All Calls**.
- 2 Select **To**.

If you specified a forwarding number for all calls before, this number displays.

To forward calls to this number, press  under **Back**.

To delete this number, press , then press and hold  under **Delete**.

- 3 To enter the number you want to forward calls to:
Enter the number using your keypad. **-or-**
Press  under **Search**. Select **Contacts**, **Recent Calls**, or **Memo**. Select the number you want to enter.
- 4 Press .

All your calls are now forwarded to the number you specified.

Turning Off Call Forwarding

If you don't want all your calls forwarded, turn the feature off:

- 1 From the main menu, select **Call Forward > To**.
- 2 Set this option to **Off**.

All your calls are now sent to your phone.

Calls you miss are forwarded according to the options set for missed calls. By default, missed calls are forwarded to voice mail.

Note: To receive voice mail messages, you must first set up a voice mail account with SouthernLINC Wireless.

Forwarding Missed Calls

You can specify a forwarding number for each type of missed call:

- **If Busy** — Your phone is on a call or transferring data.
- **If No Answer** — You do not answer on the first 4 rings.
- **If Unreachable** — Your phone is out of coverage or powered off.



Note: If you want a type of missed call sent to voice mail, the call forwarding number for that type of missed call must be your voice mail access number.



To forward missed calls:

- 1 From the main menu, select **Call Forward > Forward > Detailed**.

- 2 Select **If Busy** to specify a forwarding number for calls received when your phone is busy.
- 3 If you specified a forwarding number for this type of call before, this number displays.

To forward calls to this number, press  under **Back** and go to step 6. **-or-**

To delete this number, press , then press and hold  under **Delete**.

- 4 To enter the number you want to forward this type of call to:
Enter the number using your keypad. **-or-**
Press  under **Search**. Select **Contacts**, **Recent Calls**, or **Memo**. Select the number you want to enter.
- 5 Press .
- 6 Repeat step 2 through step 5 for **If No Answer** and **If Unreachable**.
- 7 When you are finished, press  under **Back**.

Viewing Call Forwarding Settings

- 1 From the main menu, select **Call Forward > Forward > All Calls**.
- 2 With **To** highlighted, press  under **Status**.

Advanced Calling Features

Call Waiting

Call Waiting lets you receive a second call while on an active call. Call Waiting is always available, unless you turn it off for a specific call.

If you are on a call and receive a second call, your phone emits a tone and displays a message saying you are receiving a second call.

To accept the second call and put the active call on hold:

Press  under **Yes**.

To accept the second call and end the active call:

1 Press .

Your phone rings with the second call.

2 Answer the second call.

To decline the second call:

Press  under **No**. If you subscribe to voice mail, the call is forwarded to your voice mail box, unless you set **Call Forward for If Busy** to a different number.

Turn Off Call Waiting

To turn off Call Waiting during a call:

- 1 Press .
- 2 Select **In Call Setup > Call Waiting**.
- 3 Set this option to **Off**.

Tip: To turn Call Waiting back on while still on the call, set this option to **On**.

To turn off Call Waiting for the next call you make or receive:

- 1 From the main menu, select **Settings > Phone Calls > Call Waiting**.
- 2 Set this option to **Off**.

Call Waiting is turned back on when you end the call.

Switching Between Calls

Any time you have one call active and one call on hold, to make the call on hold active and put the active call on hold:

Press  under **Switch**. -or-

If **Switch** is not one of your options: Press . Select **Switch**.

Putting a Call on Hold

- 1 While on an active call, press .
- 2 Select **Hold**.

If you want to make the call active again, press  under **Resume**.

Calling 2 People

Putting a Call on Hold, Making a Second Call

- 1 Place or receive a phone call.
- 2 While the call is active, press .
- 3 Select **2nd Call**. This puts the call on hold.
- 4 Enter the second phone number you want to call.

Tip: For quick ways to enter the number, press .

- 5 Press  to place the call.

To end the second call and make the call on hold active again:

Press .

To make the call on hold active and put the active call on hold:

Press  under **Switch**.

Merging 2 Calls into a 3-Way Call

After you put a call on hold and place a second call, you can combine these calls into a 3-way call:



- 1 Press .
- 2 Select **Join**.

All 3 people in the call can speak to and hear each other.

Making a 3-Way Call

- 1 Place or receive a phone call.
- 2 While the call is active, press .
- 3 Select **3 Way**. This puts the call on hold.
- 4 Enter the second phone number you want to call.

Tip: For quick ways to enter the number, press .

- 5 Press  to place the call.
- 6 Press  under **Join**.

All 3 people in the call can speak to and hear each other.

Creating Pauses and Waits While Dialing

You can enter a pause or wait while dialing a number. For information on using pauses and waits, see “Creating Pauses and Waits” on page 34.

To create a pause while dialing a phone number:

- 1 From the keypad, enter the digits you want to occur before the pause.
- 2 Press .
- 3 Select **Insert Pause**.
- 4 Enter the digits you want to occur after the pause.

To create a wait while dialing a phone number:

- 1 From the keypad, enter the digits you want to occur before the wait.
- 2 Press .
- 3 Select **Insert Wait**.
- 4 Enter the digits you want to occur after the wait.

Setting One Touch PTT

One Touch PTT sets your phone to call the most recent LINC ID on the recent calls list, or a LINC ID you choose, every time you press the PTT button.

To set your phone to call the most recent LINC ID on the recent calls list:

- 1 From the main menu, select **Settings > InstantLINC > One Touch PTT**.
- 2 Set this option to **Last Call**.

To set your phone to call a LINC ID you choose:

- 1 From the main menu, select **Settings > InstantLINC > One Touch PTT > Assigned Number**.
- 2 To enter the LINC ID number you want your phone to call every time you press the PTT button:

Enter the number using your keypad. **-or-** Press  under **Search**. Select **Contacts**, **Recent Calls**, or **Memo**. Select the number you want to enter.

Tip: If you are entering a Talkgroup number, enter # before the number.

- 3 Press .

To turn off One Touch PTT:

- 1 From the main menu, select **Settings > InstantLINC > One Touch PTT**.
- 2 Set this option to **Off**.

Setting Flip Actions

For Answering Calls

To set your phone to answer calls when you open the flip:

- 1 From the main menu, select **Settings > Phone Calls > Flip Activation > Flip to Ans.**
- 2 Set this option to **On**.

To set your phone not to answer calls when you open the flip:

Set **Flip to Ans** to **Off** in step 2.

For Ending Calls

To set your phone to end calls when you close the flip:

- 1 From the main menu, select **Settings > Phone Calls > Flip Activation > Flip to End.**
- 2 Set this option to **On**.

To set your phone not to end calls when you close the flip:

Set **Flip to End** to **Off** in step 2.

Note: If you are using your phone with a headset, and you have the **Flip to End** option set to **On**, closing your flip sends incoming sound to the headset and does not end the call.

Call Timers

Call timers measure the duration of your phone calls, InstantLINC Mobile to Mobile calls or group calls, and circuit data use, as well as the number of Kilobytes sent and received by your phone:

- **Last Call** — displays the duration of your most recent phone call.
- **Phone Reset** — keeps a running total of your phone call minutes, until you reset it.
- **Phone Lifetime** — displays the total minutes of all your phone calls.
- **Prvt/Grp Reset** — keeps a running total of all of your InstantLINC Mobile to Mobile calls and group call minutes, until you reset it.
- **Prvt/Grp Lifetime** — displays the total minutes of all your InstantLINC Mobile to Mobile calls and group calls.
- **Circuit Reset** — keeps a running total of all of your circuit data use, until you reset it.
- **Circuit Lifetime** — displays the total minutes of all of your circuit data use.

Advanced Calling Features

- **Kbytes Reset** — keeps a running total of the number of Kilobytes sent and received by your phone, until you reset it.

To view or reset a timer:

- 1 From the main menu, select **Call Timers**.
- 2 Select the feature you want to view or reset.
- 3 To view a feature without resetting: Press **OK** when you are finished viewing. **-or-**

To reset a feature: Press **Left Arrow** under **Reset**. Press **OK** or press **Left Arrow** under **Yes** to confirm.

Note: The values displayed by Call Timers should not be used for billing. Call timers are estimates only.

Using Your Phone as a Modem

To use your phone as a modem with a laptop, handheld device, or desktop computer:

- 1 Open the connector cover.

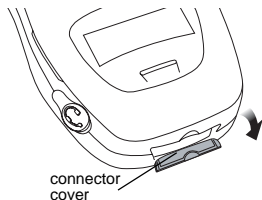

- 2 With the phone's display facing up, insert a data cable's connector into the accessory connector, until you hear a click.

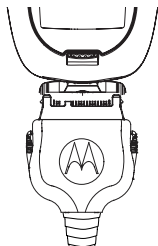

- 3 Insert the data plug into the data port of the other device.

When used as a modem, your phone has these data transfer modes:

- Circuit data — used for sending and receiving faxes and for transferring large files
- Packet data — used for small file transfers such as email

To use these services, you must install the iDEN Wireless Data Services software (available separately). For more information on setting up your computer and your i833 phone for packet and circuit data calls, refer to the Wireless Data Services User's Guide or contact SouthernLINC Wireless.

Note: Contact your SouthernLINC Wireless sales representative for more information on this feature.

Making TTY Calls

To use your phone to make phone calls using a teletypewriter (TTY) device:

- 1 Connect one end of a 2.5mm cable into the audio jack on your phone. Connect the other end of the cable to your TTY device.
- 2 Make sure that your phone's TTY feature is on and select the TTY mode you want to use.
- 3 Use your phone to enter phone numbers and make calls.

When you make a TTY call, these icons appear on the phone's display:

- ☎ Phone call is active.
- ☎ Phone call is on hold.

Advanced Calling Features

TTY device features such as Turbo-Code, High-Speed, and Interruption are not supported by your phone. These features must be turned off or disabled to use your TTY device with your phone.

Turning On the TTY Feature

Your phone's TTY feature must be on if you want to make TTY calls, set the TTY mode, or change the TTY baud rate. To make sure the TTY feature is on:

From the main menu, select **Settings > Phone Calls > TTY > Use TTY**. This field must say **On**.

Choosing a Mode

Your phone supports these TTY modes:

- **TTY** — You type and read text on your TTY device.
- **VCO** (Voice-Carry-Over) — You speak into your phone and read text replies on your TTY device.
- **HCO** (Hearing-Carry-Over) — You type text on your TTY device and listen to voice replies on your phone speaker.

To change mode while not in a call:

- 1 From the main menu, select **Settings > Phone Calls > TTY > Type**.
- 2 Select the TTY mode you want.

When you make a TTY call, the call begins in the TTY mode you last selected.

To change mode during a call using your phone:

- 1 Press **[M]**.
- 2 Select **In Call Setup > TTY > Type**.
- 3 Select the mode you want.

To change mode during a call using your TTY device, issue one of the following commands:

- “VCO please” — to select VCO mode
- “HCO please” — to select HCO mode
- “HCO off please” — to turn off HCO mode

Important: When you are using HCO, the sound coming from your phone speaker may be uncomfortably loud. Use caution when putting the phone to your ear. (For information on setting the volume of your phone speaker, see “Setting the Volume” on page 92.)

Changing the TTY Baud Rate

By default, your phone's TTY baud rate is set to 45.45, the baud rate required for TTY calls within the U.S. To make calls outside the U.S., set your TTY baud rate to 50.0.

To change the TTY baud rate:

- 1 From the main menu, select **Settings > Phone Calls > TTY > Baud**.
- 2 Select the baud rate for your location.

Group Calls

A group call is similar to an InstantLINC Mobile to Mobile call, but is made to all members of a Talkgroup at once. A Talkgroup is a predetermined group of SouthernLINC Wireless customers.

Before you can make or receive group calls, a Talkgroup must be established. After the Talkgroup is established, you must join the Talkgroup.

Joining a Talkgroup

Your sales representative or SouthernLINC Wireless establishes Talkgroups for you and assigns each Talkgroup a Talkgroup number. You can choose a name for each of your Talkgroups when you create entries for them in Contacts.

To receive group calls made to any of these Talkgroups, you must join the Talkgroup.

- 1 Press  under **Contcs.** -or-

From the main menu, scroll to **Contacts** and press .

- 2 Scroll to the Talkgroup you want to join.
- 3 Press  under **Join.**

Note: You can only monitor one Talkgroup at a time.

Making Group Calls

- 1 Press . Then enter the Talkgroup number using the keypad. -or-

Choose the Talkgroup name from Contacts or recent calls list.

- 2 Proceed as if making an InstantLINC Mobile to Mobile call.

Receiving Group Calls

To answer a group call:

Proceed as if answering an InstantLINC Mobile to Mobile call. Only one person at a time may speak on a group call.

The LINC ID or name of the person who is speaking will appear on the display below the Talkgroup number.

Turning off Group Calls

To set your phone to prevent you from hearing group calls to your Talkgroup:

- 1 From the main menu, select **Settings > InstantLINC > Tkgp Silent.**
- 2 Set this option **On.**

To set your phone to let you hear group calls to your Talkgroup:

Set **Tkgrp Silent** to **Off** in step 2.

Memo

Memo lets you store a number, make a call to that number, and save it to Contacts.



To create a memo:

- 1 From the main menu, select **Memo**.
- 2 Enter the number using your keypad.
- 3 Press .

To view the memo later:

From the main menu, select **Memo**.

To delete the memo:

- 1 From the main menu, select **Memo**.
- 2 Press and hold  under **Delete**.
- 3 Press .

To edit the memo:



- 1 From the main menu, select **Memo**.
- 2 Enter the new number.
- 3 Press .

To make a call to the memo number:

- 1 From the main menu, select **Memo**.
- 2 To make a phone call, press . **-or-**

To make an InstantLINC Mobile to Mobile call, press the PTT button.

To store the memo number to Contacts:

- 1 From the main menu, select **Memo**.
- 2 Press .
- 3 Select **Store to Cntcs**.
- 4 To store the number as a new entry, select **[New Contact]**. **-or-**
To store the number to an existing entry, select the entry.
- 5 With the Contacts type field highlighted, scroll left or right to display the Contacts type you want to assign the number.
- 6 Press  under **Done**.

Ring Tones

To set the ring tone your phone makes when you receive phone calls, call alerts, message notifications, or Datebook reminders:

- 1 From the main menu, select **Ring Tones**.
- 2 Make sure **VibeAll** is set to **Off**.
- 3 Scroll through the list of ring tones and select the one you want to assign. **Vibrate** sets your phone to vibrate instead of making a sound; **Silent** sets your phone to neither vibrate nor make a sound.

Tip: Highlighting a ring tone lets you hear it.

- 4 Select the features you want to assign the ring tone to.
- 5 When you are finished, press  under **Done**.

Note: This icon  appears on the display if you set your phone to neither vibrate nor make a sound for phone calls.

Setting Your Phone to Vibrate

You can set your phone to vibrate instead of making a sound when you receive all phone calls, InstantLINC Mobile to Mobile calls, group calls, call alerts, message notifications, and Datebook reminders.

- 1 From the main menu, select **Ring Tones > VibeAll**.
- 2 Set this option to **On**.

Tip: Pressing the volume controls to turn down the volume as far as possible sets **VibeAll** to **On**.



To set your phone to vibrate instead of making a sound for some features but not others:

- 1 From the main menu, select **Ring Tones**.
- 2 Make sure **VibeAll** is set to **Off**.
- 3 Select **Vibrate** from the list of ring tones.
- 4 Select the features you want to set to make no sound.
- 5 When you are finished, press  under **Done**.

Note: To set ring options for InstantLINC Mobile to Mobile calls, and group calls, see “Setting Your Phone to Vibrate” on page 92.

Ring Tones



These icons indicate how the ringer is set.

-  The phone always vibrates instead of making a sound.
-  The phone vibrates instead of making a sound for phone calls.
-  Group calls and InstantLINC Mobile to Mobile calls are heard through the earpiece, not the speaker.

These icons may appear at the same time.

Ring and Vibrate

To set your phone to ring and vibrate when you receive phone calls or call alerts:

- 1 From the main menu, select **Ring Tones**.
- 2 Make sure **VibeAll** is set to **Off**.
- 3 Scroll through the list of ring tones and highlight the one you want to assign.
- 4 Press .
- 5 Select **Assign w/Vibe**.
- 6 Select the features you want to set to ring and vibrate.
- 7 When you are finished, press  under **Done**.

This icon  appears on the display.

Assigning Ring Tones to Contacts

You can set the ring tone your phone makes when you receive phone calls or call alerts from someone you have stored in Contacts.

- 1 From the main menu, select **Ring Tones**.
- 2 Make sure **VibeAll** is set to **Off**.
- 3 Scroll through the list of ring tones and select the one you want to assign.
- 4 Select **A Contact**.
- 5 Select the Contacts entry you want to assign the ring tone to.

Viewing Ring Tone Assignments

- 1 From the main menu, select **Ring Tones**.
- 2 Make sure **VibeAll** is set to **Off**.
- 3 Highlight any ring tone.
- 4 Press .
- 5 Select **Overview**.
- 6 Scroll to view ring tones assigned to features and Contact entries.

Downloading More Ring Tones

If you want to use other ring tones, you can download them into your phone for a fee. Go to <http://www.southernlinc.com/downloads> for a selection of custom ring tones and downloading instructions.

Note: Ring tones purchased from this web site may be downloaded only once. If you delete a ring tone from your phone, you must purchase it again to download it again.

Managing Memory

To view the amount of memory available for custom ring tones:

- 1 From the main menu, select **Ring Tones**.
- 2 Make sure **VibeAll** is set to **Off**.
- 3 Highlight any ring tone.
- 4 Press .
- 5 Select **Memory Usage**.



Deleting custom ring tones frees memory.

Note: Ring tones are stored in your phone using the same memory space used to store messages, voice records, Java applications, pictures, and wallpaper images. Deleting some of these other items frees memory for ring tones.

Deleting Custom Ring Tones





Deleting a ring tone from the list of ring tones deletes it from all parts of your phone, including Contacts.

To delete a custom ring tone:

- 1 From the main menu, select **Ring Tones**.
- 2 Make sure **VibeAll** is set to **Off**.
- 3 Scroll to the ring tone you want to delete.
- 4 Press .
- 5 Select **Delete**.
- 6 Press  under **Yes** to confirm.

Entering Text

You can enter text, numbers, and symbols into your phone using Alpha, Word, Numeric, or Symbol text input modes.

-  **Alpha** — Press a key several times for each character.
-  **Word** — Press a key once for each letter while words likely to be the one you want are chosen from a database.
-  **Symbols** — Enter punctuation and other symbols.
-  **Numeric** — Enter numbers.

When you access a screen that requires you to enter text, you start in the mode last used.

To choose a text input mode:

- 1 At a screen that requires you to enter text, press .
- 2 Select the text input mode you want to use. A checkmark appears next to the current mode.





Using Alpha Mode

- Press any key on the keypad to enter the letters, numbers, and symbols on that key. For example, to enter the letter Y, press  three times.
- Type a letter then scroll up to make that letter uppercase, or type a letter then scroll down to make that letter lowercase.
- See “Special Function Keys” on page 53 for more information on adding spaces, capitalization, and punctuation.

Using Word Mode

In Word mode, T9 Text Input analyzes the letters on the keypad button you press and arranges them to create words. As you type, T9 Text Input matches your keystrokes to words in its database and displays the most commonly used matching word. You can add your own words to this database.

Entering a Word

- 1 Select Word as your text input mode.
- 2 Type a word by pressing one key for each letter.
For example, to type “test” press    .

The displayed word may change as you type it. Do not try to correct the word as you go. Type to the end of the word before editing.

- 3 If the word that appears is not the desired word, press  to change the word on the display to the next most likely word in the database.

Repeat until the desired word appears.

If the desired word does not appear, you can add it to the database.

Adding Words to the Database

- 1 Select Alpha as your text input mode.
- 2 Type the word using Alpha mode.
- 3 Select Word as your text input mode.
- 4 Press .

The word you typed in Alpha text entry mode is now in the database.

Note: You cannot store alphanumeric combinations, such as Y2K.

Choosing a Language

To change the language of the database:

- 1 At a screen that requires you to enter text, press .
- 2 Select **Languages**.

- 3 Select the language you want for your database.



Special Function Keys

Some of the phone's keys assume different functions while in Alpha or Word mode.



Spaces

Press  for a space.

Capitalization

When you press and hold the  key, it acts as a 3-way toggle. Press and hold  to make the next letter typed uppercase (shift), to make all subsequent letters typed uppercase (caps lock), or to go back to lowercase letters.

These icons appear in the top row of your display:

 or  Shift is on.



 or  Caps lock is on.

When neither of these icons appear, letters typed are lowercase. Scrolling up after typing a letter makes that letter uppercase.

Note: Your phone automatically makes the first letter of a sentence uppercase.

Entering Text

Punctuation

Press  or  to insert punctuation. Continue to press the key to view the list of symbols available through that key. Pause to select the symbol you want.

Note: Additional punctuation symbols are available in Symbols mode.

Using Numeric Mode

- 1 Select **Numeric** as your text input mode.
- 2 Press the number buttons on your keypad to enter numbers.

Using Symbols Mode

- 1 Select Symbols as your text input mode.
A row of symbols appears along the bottom of the phone's display. Scroll right to view the complete row.
- 2 Press  to select the highlighted symbol.

Messages

You can receive the following types of messages on your phone:

- Voice mail messages
- Text messages
- Net Alerts
- Fax mail

You have 2 ways to access the messages you receive:

- Respond to the message notification that appears when the message is received.
- Dismiss the message notification and access the message later through the message center.

You can listen to or view these messages, delete them, or continue to store them in the message center.

Message Notifications

When you receive a message, your phone notifies you with text on the display and a notification tone or vibration. You can access the message or dismiss the notification.

If you dismiss the notification, the message is not deleted. It can be accessed through the message center.

If you are not on a phone call when you receive a message, your phone sounds a notification tone every 30 seconds until you access the message, you dismiss the notification, or the alert time-out expires.

When you are on a phone call, you can receive message notifications for all types of messages.

Setting Notification Options

To control whether your phone sounds message notification tones while you are on phone calls:

- 1 From the main menu, select **Settings > Phone Calls > Notifications**.
- 2 Select the option you want:
 - **Receive All** — Tones sound during calls for all types of messages.
 - **Msg Mail Only** — Tones sound during calls for SMS messages; tones for all other types of messages are held until you end calls.
 - **Delay All** — Tones for all types of messages are held until you end calls.

Tip: To set notification options during a call: Press . Select **In Call Setup > Notifications**.



Messages

Message Center

The message center manages your messages.

All your messages are stored in the message center. The message center shows how many messages you have of each type.

To access your messages through the message center:

- 1** From the main menu, select **Messages**.
- 2** Scroll to the type of message you want to access.
- 3** Press  or press  under the display option on the left.

Voice Mail Messages

Note: To receive voice mail messages, you must first set up a voice mail account with SouthernLINC Wireless.

Receiving a Message

When you receive a voice mail message, **New Voice Mail Message** appears on the display.

To call the SouthernLINC Wireless voice mail system and listen to the message:

Press  under **Call**.

To dismiss the message notification:

If the flip is closed, press . **-or-**

If the flip is open, press  or press  under **Back**, or close the flip.

If the caller leaves a message, this icon  appears on the display, reminding you that you have a new message.

Accessing Voice Mail from the Message Center

From the main menu, select **Messages > Voice Mail**.

Sending Unanswered Calls to Voice Mail

To send a phone call to voice mail instead of answering it:

If the flip is closed, press . **-or-**

Press . **-or-**

Press  under **No**.

Text Messages

Your phone can send and receive short messages and net alerts.

Setting Up

Before you begin using text messages, you may need to set up your signature, service center number, and expiration information:

- 1 From the main menu, select **Messages**.
- 2 Scroll to **Text Inbox**.
- 3 Press .
- 4 Select **Text Msg Setup**.
- 5 Select **Signature**.

Enter your signature. It may be up to 11 characters long. When you are finished, press .

- 6 Select **Srvc Cntr No**.

Enter the phone number of your service center. If you do not know this number, contact SouthernLINC Wireless.

When you are finished, press .

- 7 Select **Expire After**.

This is the amount of time messages you send are saved at the service center if they cannot be delivered. After this period, they are discarded.

Scroll to select the number of days you want your messages to be saved.

When you are finished, press .

- 8 Select **Auto Clean Up**. Set this option to **On** if you want your phone to delete sent messages.

If you set **Auto Clean Up** to **On**, select **Clean Up After** to set the number of days after which sent messages are deleted or the number of messages to be kept.

- 9 Press  under **Done** to save the information you entered.

Receiving a Message

To view the message:

Press  under **Read**.

To dismiss the message notification:



If the flip is closed, press . **-or-**

If the flip is open, press  under **Exit** or close the flip.

If your phone is powered off when you receive a text message, or net alert, your phone notifies you the next time you power it on. If you are out of your coverage area, your phone alerts you when you return to your coverage area.



Tip: While reading a text and numeric message that contains a phone number, you can press  to call that number.

Reading from the Message Center

- 1 From the main menu, select **Messages > Text Inbox**.
- 2 Select the message you want to read. **-or-**
Press the number of the message you want to read.
- 3 If the message fills more than one screen, scroll to read it.
Tip: Scrolling through one message lets you view the next message.
- 4 To save the message, press  under **Ok**. **-or-**
To reply to the message, press  under **Reply**. **-or-**
To see all other choices, including forwarding and deleting the message, calling the sender, or

storing the sender's number in Contacts, press .



Creating and Sending Messages

- 1 From the main menu, select **Messages > [Create Message]**. **-or-**
Select **[Create Message]** from Text Inbox, Text Outbox, or Drafts. **-or-**
Highlight Quick Notes and press  under **Compose**.
Tip: This option is available from many context-sensitive menus in the message center.
- 2 To address the message:
Use the keypad to enter the phone number of the person you want to send the message to. **-or-**
Press  under **Browse**. Select **Contacts**, **Recent Calls**, or **Memo**. Select the number you want to enter.
When you are finished, press .
- 3 Enter the text of the message. **-or-**

Text Messages

To use a quick note: Press  under **Browse**. Scroll to the quick note you want. For more information on quick notes, see “Using Quick Notes”.

When you are finished, press .

- 4 If you want to send the message, press  or press  under **Send**. -or-

To delete the message without sending it, press  under **Cancel**. -or-

If you want to request confirmation of delivery, save the message as a draft, or set the sending method, press . Select the option you want.

Beginning Messages From the Recent Calls List

- 1 From the recent calls list, scroll to the name you want to send a message to.
- 2 If the entry has more than one phone number stored, view the phone number you want to send the message to.
- 3 Press .
- 4 Select **Compose SMS**. The message is automatically addressed to the phone number you chose.
- 5 Follow step 3 through step 4 of “Creating and Sending Messages” on page 59.



Beginning Messages From the Idle Screen

- 1 Using the keypad, enter the number you want to send a message to.
- 2 Press .
- 3 Select **Compose SMS**. The message is automatically addressed to the phone number you chose.
- 4 Follow step 3 through step 4 of “Creating and Sending Messages” on page 59.

Using Quick Notes

Quick notes are short, pre-written text messages that you can create, edit, and send. You can store up to 20 quick notes. A quick note may be up to 30 characters long.

To create a quick note:

- 1 From the main menu, select **Messages > Quick Notes > [New Note]**.
- 2 Press  or press  under **Create**. Enter text. -or-

To choose from pre-installed notes, select the note you want.

Tip: For more options, including sending the quick note, press .

Using Drafts



When you save a message as a draft, it is saved in the drafts folder.

To edit a draft:

- 1 From the main menu, select **Messages > Drafts**.
- 2 Select the draft you want to edit.
- 3 To edit the fields you want to change, follow step 2 through step 4 in “Creating and Sending Messages” on page 59.



Resending Messages

To resend a message:



- 1 From the main menu, select **Messages > Text Outbox**.
- 2 Scroll to the message you want to resend. **-or-**
Press the number of the message you want to resend.
- 3 Press . **-or-**
Press . Select **Resend**.

Deleting Sent Messages

To delete a sent message:

- 1 From the main menu, select **Messages > Text Outbox**.
- 2 Scroll to the message you want to delete.
- 3 Press  under **Delete**.
- 4 Press  under **Yes** to confirm.

To delete all unlocked sent messages:

- 1 From the main menu, select **Messages > Text Outbox**.
- 2 Press .
- 3 Select **Delete All**.
- 4 Press  under **Yes** to confirm.

Locking and Unlocking Sent Messages

When you lock a message, it cannot be deleted until you unlock it.

Locking a Message

- 1 From the main menu, select **Messages > Text Outbox**.
- 2 Scroll to the message you want to lock or unlock.
- 3 Press .

Text Messages

- 4 Select **Lock**.

Unlocking a Message

- 1 From the main menu, select **Messages > Text Outbox**.
- 2 Scroll to the message you want to lock or unlock.
- 3 Press  under **Unlock**.

Sorting Messages

You can sort messages in your inbox by sender, time and date, and status. You can sort messages in your outbox by recipient, time and date, and status.

- 1 From the main menu, select **Messages > Text Inbox** or **Messages > Text Outbox**.
- 2 Highlight any messages.
- 3 Press .
- 4 Select **Sort and Order**.
- 5 Select **Sort By** to specify the sorting method.
- 6 Select **Order By** to specify the sorting order.

Managing Memory

Your text inbox, outbox, and drafts folder have a set amount of memory available for storing messages.

The text inbox holds 20 messages. If the text inbox is full, you cannot receive messages until you delete some.

The outbox and drafts folder share memory space. Together they can hold 30 messages. If the outbox and drafts folder memory is full, you cannot send messages or save drafts until you delete some.

To view the amount of memory available in your text inbox:

- 1 From the main menu, select **Messages > Text Inbox**.
- 2 Press  under **Memory**.

To view the amount of memory available in your outbox and drafts folder:

- 1 From the main menu, select **Messages > Text Outbox** or **Messages > Drafts**.
- 2 Press  under **Memory**.

My Info

My Info lets you view information about your phone and send this information to other phones.

Viewing My Info

- 1 From the main menu, select **My Info**.
- 2 Scroll to see the entire screen.

The My Info screen contains:



- **My Name** — You can enter your name here.
- **Line 1** and **Line 2** — your phone numbers for phone lines 1 and 2. Each number appears when you receive your first call on that line.
- **LINC ID** — Your LINC ID is the number that others use to contact you using InstantLINC Mobile to Mobile. This number appears when you receive your first InstantLINC Mobile to Mobile call.
- **Group ID** — the number of the Talkgroup you have joined.
- **Carrier IP** — the IP address assigned to SouthernLINC Wireless. This number appears when you register for packet data services.
- **IP1 Address** and **IP2 Address** — the IP addresses you use to access the Internet with your phone.

- **Circuit Data** — the number you use if you want to use your phone to transfer circuit data. See “Using Your Phone as a Modem” on page 42. You receive this number from SouthernLINC Wireless.

Note: If you request equipment-related transactions on your account, SouthernLINC Wireless may require you to provide specific information about your phone. By pressing  anytime while in My Info, a submenu will appear that includes your phone's service status, unit information, and phone identification numbers including IMEI, SIM ID, and Serial Number (SN). Please be prepared to supply the representative with this information when requesting these types of transactions.

Editing My Info

To edit My Info to enter or change the text that appears in **My Name**:

- 1 From the main menu, select **My Info**.
- 2 Press  under **Edit**.
- 3 Select **Name**.
- 4 Enter the name you want to appear. See “Entering Text” on page 52. When you are finished, press .

My Info

You can also edit the information in **Line 1**, **Line 2**, and **Ckt**, but your changes are only temporary. The next time your phone registers on the network, your actual phone numbers and circuit data number appear again in My Info.

Setting Sending Options

Your phone can send information in My Info to other phones that have this capability.

You can control what portion of the information in My Info is sent and whether it is sent automatically in every InstantLINC Mobile to Mobile call or only when you choose to send it.

Information Sent

The information your phone sends always includes **My Name** and **LINC ID**.

It may include **Line 1**, **Line 2**, **Carrier IP**, and **Circuit Data**, depending how you set your sending options.

To change which fields are sent:

- 1 From the main menu, select **My Info**.
- 2 Press **□**.
- 3 Select **LINC View Setup > Info to Send**.

- 4 A checkmark appears next to the fields that will be sent. To add or remove the checkmark, select the field.
- 5 When you are finished, press **⏪** under **Done**.

Automatic Sending

To control whether your information is sent automatically:

- 1 From the main menu, select **My Info**.
- 2 Press **□**.
- 3 Select **LINC View Setup > Auto Send**.
- 4 To set your information to be sent automatically, set this option to **On**. -or-

To set your information to be sent only when you choose to send it, set this option to **Off**.

Using LINC View

LINC View lets you exchange My Info and contact information with other phones that have this capability. You do this through InstantLINC Mobile to Mobile calls.

LINC View cannot be used during group calls.

Sending My Info and Contact Information

When you send My Info or contact information using LINC View, the information you sent appears on the display of the phone you are engaged in the InstantLINC Mobile to Mobile call with. After the call, the information appears on the recent call list of that phone.

Sending My Info

You can control what portion of the information in My Info is sent and whether it is sent automatically in every InstantLINC Mobile to Mobile call or only when you choose to send it. See “Setting Sending Options” on page 64.

Tip: When you send My Info, certain information, such as your email address or fax number, cannot be included. To send complete contact information, create an entry for yourself in Contacts and send.

Sending Information During a Call

- 1 While in an InstantLINC Mobile to Mobile call, press .
- 2 Select **LINC View My Info**.
- 3 When **Ready to Send** appears on the display, press the PTT button to send the information.

Starting a Call by Sending Information

- 1 From the main menu, select **My Info**.
- 2 Press .
- 3 Select **LINC View My Info**.
- 4 Use the keypad to enter the LINC ID you want to send the information to. **-or-**

Press  under **Browse**. Select **Contacts**, **Recent Calls**, or **Memo**. Select the number you want to enter.

- 5 When **Ready to Send** appears on the display, press the PTT button to send the information.

Using LINC View

Sending Contact Information

You can send contact information by selecting a Contacts entry or an item from the recent calls list.

Contacts entries that contain only addresses cannot be sent. When Contacts entries are received, they do not include ring tones or pictures.

These items from the recent calls list can be sent:

- Contact information sent from other phones
- Calls to or from numbers store in your Contacts list

Sending Information During a Call

- 1 While in an InstantLINC Mobile to Mobile call, press .
- 2 Select **Contacts** or **Recent Calls**.
- 3 Scroll to the Contacts entry or item in the recent calls list you want to send.
- 4 When **Ready to Send** appears on the display, press the PTT button to send the information.

Starting a Call by Sending Information

- 1 From the Contacts list, scroll to or select the entry you want to send. **-or-**
From the recent calls list, scroll to or select the item you want to send.
- 2 Press .

- 3 Select **LINC View Contact**.

- 4 Use the keypad to enter the LINC ID you want to send. **-or-**

Press  under **Browse**. Select **Contacts**, **Recent Calls**, or **Memo**. Select the number you want to enter.

- 5 When **Ready to Send** appears on the display, press the PTT button to send the information.

Receiving My Info or Contact Information

When you receive My Info or contact information from another phone, an icon appears on the display:

 My Info.

 Contact information.

To view the information while still in the InstantLINC Mobile to Mobile call:



- 1 Press .
- 2 Select **View Contact**.

You can also view My Info from other phones on the recent calls list. See “Recent Calls” on page 25.

Updating Contacts

When you receive a call and see an icon next to the name of the person who called you, you can update the contact for that person.

To update the contact:

- 1 When you see an icon next to a contact, press .
- 2 Select **Update Contacts**.
- 3 Press .

Datebook

Datebook stores up to 250 events. You can store events over a 13 month period — 12 months after and 1 month before the current date.

A Datebook event contains:

- A subject — A name you assign to the event. You can also enter a phone number, LINC ID, or Talkgroup number here. After the event is stored, you can call this number from Datebook or when you get a reminder of this event.
- A location — The location of the event. You can also enter a phone number, LINC ID, or Talkgroup number here. After the event is stored, you can call this number from Datebook or when you get a reminder of this event.
- A start time — The start time automatically assigned to an event is the beginning of the day. You can change the start time, or assign no start time, before storing the event.
- A duration — the length of time the event lasts
- A date — The date automatically assigned to an event is the date that was highlighted or selected when you began creating the event. You can change this date before storing the event.

- A repeat — lets you store the event as a recurring event.
- A reminder — If an event has a start time, you can set Datebook to remind you that the event is going to start.
- a ring tone for the reminder
- a profile that your phone is switched to while the event is occurring
- a Java application that starts when the event starts

Only the subject and date are required.

Viewing Datebook

To access Datebook:

From the main menu, select **Datebook**.

You can view Datebook by the day, by the week, or by the month. You can also view the details of any event.

In day view, brief information about each event for that day appears.

In week view, events appear as markers corresponding to their times.

In month view, days with events appear with a marker in the corner.

To view an event:

- 1 Select the day the event occurs.
- 2 Select the event.

To change the current view:

- 1 While viewing Datebook, press .
- 2 Select the view you want.

Navigating Datebook

To scroll through Datebook:

Scroll left and right using the navigation key. **-or-**

In week view and month view, press  or .

To see more in day view:

Scroll up and down using the navigation key.

To highlight a day in month view:

Enter the date using the keypad.

To go to today's date:

- 1 While viewing Datebook, press .
- 2 Select **Go To Today**.

To go to any date in Datebook:

- 1 While viewing Datebook, press .
- 2 Select **Go To Date**.
- 3 Select the date you want.

Creating Events

Every Datebook event must have a subject and be stored to a date. Other information is optional.

You may enter the information in any order by scrolling through the event details.

After you have entered the information you want, you can press  under **Done** to store the event to Datebook.

If you decide you don't want to store the event:

Press  under **Cancel**.

To create a Datebook event:

- 1 While viewing datebook, press  under **New**.
-or-

In day view, select **[New Event]**.

- 2 To assign a subject to the event:

Select **Subject**.





Enter the name. **-or-**

Press  under **Browse** to choose from common event names. **-or-**

Enter a phone number, LINC ID, or Talkgroup number. After the event is stored, you can call this number.

When you are finished, press .

Datebook

- 3** If you want to assign a location to the event:
Select **Location**.
Enter the location. **-or-**
Enter a phone number, LINC ID, or Talkgroup number. After the event is stored, you can call this number.
When you are finished, press .
- 4** The start time automatically assigned to an event is the beginning of the day. If you want to change the start time or assign no start time:
Select **Start**.
Enter the start time you want. **-or-**
Press  under **No Time** to assign no start time.
- 5** If you want to assign a duration to the event:
Select **Duration**.
Select the duration you want. **-or-**
Select **Custom** to enter a duration.
- 6** The date automatically assigned to an event is the date that was highlighted or selected when you began creating the event. To change the date of the event:
Select **Date**.
Enter the date you want.
- 7** If you want to make the event a recurring event:
Select **Repeat**.
Select the repeat cycle you want.
If the event occurs more than once a week:
Select **Multiple Day**. Select the days you want.
Press  under **Done**.
Select the date you want this event to stop recurring.
- 8** If you want to create a reminder for this event:
Select **Reminder**.
Select the reminder time you want. **-or-**
Select **Custom** to enter a reminder time.
Note: If an event has no start time, you can not create a reminder for it.
- 9** If you have entered all the information you want for this event, press  under **Done**. **-or-**
If you want to assign a ring tone, a profile, or a Java application to the event, see "Assigning More Options" on page 71.

Assigning More Options

To assign more options before storing an event:

- 1 If you have created a reminder for the event and want to set the ring tone for that reminder:

Select **Ring Tone**.

Select the ring tone you want from the ring tones stored in your phone.

- 2 If you want to assign a profile that your phone is switched to while the event is occurring:

Select **Profile**.

Select the profile you want from the profiles stored in your phone.

Your phone switches to this profile when the event starts and switches back to the previous profile when the event ends.

- 3 If you want to assign a Java application to start when the event starts:

Select **App**.

Select the application you want from the Java applications stored in your phone.



If you created a reminder for this event, your phone prompts you to start the Java application when you get the reminder.

Editing Events

To change the details of an event:

- 1 Select the day the event occurs.
- 2 Select the event.
- 3 Press  under **Edit**.
- 4 Follow the applicable instructions in “Creating Events” on page 69 to edit the various fields.



To copy an event to another date:

- 1 Select the day the event occurs.
- 2 Select the event.
- 3 Press .
- 4 Select **Copy**.
- 5 Press  under **Yes** to confirm.
- 6 Enter the date you want.
- 7 Press .
- 8 If you want to change more information, follow the applicable instructions in “Creating Events” on page 69 to edit the various fields.

Deleting Events

- 1 Select the day the event occurs.
- 2 Select the event.
- 3 Press .
- 4 Select **Delete**.

Datebook

5 If the event is not a recurring event, press  or press  under **Yes** to confirm. **-or-**

If the event is a recurring event:

Select **This Event Only** to delete only the event selected in step 2.

Select **Repeat Event** to delete all occurrences of the event.

Receiving Reminders

If you created a reminder for a Datebook event, when the reminder time occurs, your phone notifies you with text on the display and a reminder tone.



To view more details about the event:

Open the flip. **-or-**

Press  under **View**.

To dismiss the reminder:

If the flip is closed, press . **-or-**

If the flip is open, press , press  under **Dismiss**, or close the flip.

For Events with Java Applications

If you assigned a Java application to start when the event starts, you can start the application when you get the reminder.

1 Press .

2 Select **Launch**.

For Events with Numbers to Call

If you stored a phone number, LINC ID, or Talkgroup number in the **Subject** or **Location** field of a Datebook event, you can call or send a call alert to that number from the reminder for that event.

Making Calls from Reminders

You can make phone calls, InstantLINC Mobile to Mobile calls and Group calls to numbers in Datebook reminders.

To call a number from a reminder:

Press .

To make InstantLINC Mobile to Mobile calls or Group calls to a number from a reminder:

Press the PTT button.

Making Calls From Datebook

If you stored a phone number, LINC ID, or Talkgroup number in the **Subject** or **Location** field of a Datebook event, you can call or send a call alert to that number from Datebook.

you store numbers in both the **Subject** and **Location** fields, you can call or send a call alert to the number stored in **Subject** and the number stored in **Location** as long as the number stored in **Subject** is an InstantLINC Mobile to Mobile or Talkgroup number and the number stored in **Location** is a phone number.

If both are the same type of number, the number stored in **Subject** is called or sent a call alert. To call or send a call alert to the number stored in **Location**, you must delete the number stored in **Subject**.

To make a call or send a call alert:

- 1 Highlight or select the event containing the number you want to call or send a call alert to.
- 2 To make a phone call:

Press . -or-

Press . Select **Call # in Event**.

To make an InstantLINC Mobile to Mobile call or group call:

Press and hold the PTT button on the side of your phone. -or-

If you did not include a # before the Talkgroup you want to call: Press . Select **Talkgroup**.

To send a call alert:

Press . Select **Alert # in Event**.

Customizing Datebook Setup

To access Datebook set up options:

- 1 From the main menu, select **Datebook**.
- 2 Press .
- 3 Select **Setup**.

You can view or change these options:

- **Start View** — sets Datebook to start in day view, week view, or month view when you access Datebook.
- **Daily Begin** — sets the beginning of your day. This is the earliest time of day displayed in week view, if you have a 12-hour day view.
- **Delete After** — sets the amount of time Datebook waits to delete an event after it occurs.
- **Time Shift** — lets you shift the times of all Datebook events. This is useful if you are traveling to a different time zone.

Datebook





- **Alert Timeout** — sets the amount of time a tone continues to sound when you receive a Datebook reminder.
- **Clock** — controls whether the time and date appear on the idle screen; sets time and date format; sets year.

Java Applications

Your phone arrives with Java applications loaded and ready to install. You can download and install more Java applications.

Note: Using Java applications may cause your phone to use up more battery power than other uses of your phone.

Installing Applications

- 1 From the main menu, select **Java Apps**.
- 2 Select the application or suite of applications you want to install.
Installation messages appear as the application installs.
- 3 If you want to create a shortcut to the Java application on the main menu: Press  under **Next**. Press  under **Yes**. Press .
- 4 Press  under **Done**.

Running Applications

To run an application that has a shortcut on the main menu:

- 1 From the main menu, select the application or suite of applications you want to run.

- 2 If you have selected a suite of applications, select the application you want to run.

To run an application that does not have a shortcut on the main menu:

- 1 From the main menu, select **Java Apps**.
- 2 Select the application or suite of applications you want to run.
- 3 If you have selected a suite of applications, select the application you want to run.

Tip: If you don't hear the sounds associated with the Java application, select **Settings > Volume** and check the volumes of **Java Speaker** and **Java Earpiece**.

Suspending Applications

When you suspend an application, it does not stop running. It goes to the background so that you can run another application in the foreground.

To suspend an application:

Press  or close the flip.

To view your suspended applications:

From the Java menu, select **Suspended Apps**.

You can have up to 3 applications running at one time — 1 running in the foreground and 2 in the background.

Resuming Applications

You can resume a suspended application at any time. This brings it to the foreground.

- 1 From the Java menu, select **Suspended Apps**.
- 2 Select the application you want to resume.

Ending Applications

To end an application:



- 1 From the main menu, select **Java Apps**.
- 2 If the application you want to end is part of a suite of applications, select the suite.
- 3 Scroll to the application you want to end.

Press  under **End**. -or-

If **End** is not one of your options: Press .
Select **End**.

Tip: You can also end applications from the **Suspended Apps** screen.

To end all applications:

- 1 From the main menu, select **Java Apps**.
- 2 Scroll to **Suspended Apps**.
- 3 Press .
- 4 Select **End All**.
- 5 Press  or press  under **Yes** to confirm.

- 6 If you want to end all applications without letting them exit, press  under **EndNow**.





Downloading Applications

If you want to run more Java applications, you can download them into your phone.

Go to <http://www.southernlinc.com/downloads> for a selection of Java applications and downloading instructions.

Deleting Applications

To delete an application:

- 1 From the main menu, select **Java Apps**.
- 2 Scroll to the application you want to delete.
- 3 Press .
- 4 Select **Deinstall**.
- 5 Press  or press  under **Yes** to confirm.
- 6 When your phone has finished deleting the application, press  under **Done**.



To delete all Java applications:

- 1 From the main menu, select **Java Apps**.
- 2 Scroll to **Java System**.
- 3 Press .
- 4 Select **Delete All**.

5 Press **OK** or press  under **Yes** to confirm.

Managing Memory

To view the amount of memory available for Java applications:

- 1 From the main menu, select **Java Apps > Java System**.
- 2 Press  under **Next**.
- 3 To see more memory information, press  under **Next** again.

Deleting Java applications frees memory.

Note: Java application data is stored in your phone using the same memory space used to store messages, voice records, pictures, ring tones, and wallpaper images. Deleting some of these other items frees memory for Java applications.

Shortcuts on the Main Menu

When you install an application, you can create a shortcut to the application on the main menu.

To create a shortcut to an application that is already installed:

- 1 From the main menu, select **Settings > Personalize > Menu Options > Add/Remove Apps**. -or-

From the main menu: Press . Select **Main Menu Setup > Add/Remove Apps**.

- 2 Scroll to view the list of Java applications. Any application that has a shortcut on the main menu has a checkmark next to it.
- 3 Scroll to the application you want to create a shortcut for.
- 4 Press **OK**.
- 5 Press  under **Done**.

To remove a shortcut:

- 1 From the main menu, select **Settings > Personalize > Menu Options > Add/Remove Apps**. -or-

From the main menu: Press . Select **Main Menu Setup > Add/Remove Apps**.

- 2 Scroll to view the list of Java applications. Any application that has a shortcut on the main menu has a checkmark next to it.
- 3 Scroll to the application you want to remove the shortcut for.

Java Applications

4 Press .

5 Press  under **Done**.

Java Applications and GPS Enabled

Some Java applications can make use of your phone's GPS feature to determine the approximate geographical location of your phone. (See "GPS Enabled" on page 81 for more information on the GPS feature.) However, for privacy reasons, you may not always want Java applications to access the location of your phone. Your phone protects your privacy by giving you the option to block all or some Java applications from accessing the location of your phone.

Setting Privacy for All Java Applications

These options control the privacy of all Java applications on your phone:

- **Restricted** — No Java or similar software applications may access the location of your phone. However, location information may still be available to the phone's owner, fleet manager, or account administrator.

- **Unrestricted** — All Java applications may access the location of your phone, without notifying you.
- **By Permission** — When a Java application attempts to access the location of your phone, you are prompted to give permission. However, location information may still be available to the phone's owner, fleet manager, or account administrator.

See "Setting Privacy Options" on page 86 for information on choosing these options.

Granting or Denying Permission

If you choose **By Permission**, you must grant or deny each Java application access to the location of your phone when the application requests access for the first time. You may be required to grant or deny subsequent requests from the same application, depending on the privacy setting you choose for the individual Java application (see "Setting Privacy for Each Java Application" on page 79).

When a Java application requests access to the location of your phone, a screen appears informing you.

To deny this request:

- 1 Press  under **Deny**. The application does not access the location of your phone.
- 2 Select the denying option you want:
 - **Always** — If the application requests access to the location of your phone again, the request is denied without notifying you.
 - **For this session** — If the application requests access to the location of your phone again before you power off your phone, the request is denied without notifying you.
 - **Only Once** — If the application requests access to the location of your phone again, you are prompted to grant or deny permission.

To grant this request:

- 1 Press  under **Grant**. The application accesses your phone's location.
- 2 Select the granting option you want:
 - **Always** — If the application requests access to the location of your phone again, the request is granted without notifying you.
 - **For this session** — If the application requests access to the location of your phone again before you power off your phone, the request is granted without notifying you.

- **Only Once** — If the application requests access to the location of your phone again, you are prompted to grant or deny permission.

Setting Privacy for Each Java Application

After a given Java application requests access to the location of your phone for the first time, you have the opportunity to set the GPS privacy option for that Java application.

- 1 From the main menu, select **Java Apps**.
- 2 Scroll to the application or suite of applications you want to set the privacy option for.
- 3 Press .
- 4 Select **Permissions**.
- 5 Select the privacy option you want for this application:
 - **Always** — The application always has permission to access the location of your phone, without notifying you.
 - **Ask** — When the application requests access to the location of your phone, you are prompted to grant or deny permission (see “Granting or Denying Permission” on page 78).

Java Applications

- **Never** — When the application requests access to the location of your phone, the request is denied without notifying you.

GPS Enabled

Your phone's GPS Enabled feature uses information from Global Positioning System (GPS) satellites orbiting the Earth to determine the approximate geographical location of your phone, expressed as latitude and longitude. The availability and accuracy of this location information (and the amount of time that it takes to calculate it) will vary depending on the environment in which you are using the GPS feature. For example, GPS location fixes are often difficult to obtain indoors, in covered locations, between high buildings, or in other situations where you have not established a clear broad view of the sky. **SEE: "IMPORTANT: Things to Keep in Mind".**

When you make a 911 emergency call, the GPS feature of your phone can help emergency personnel locate you if your phone has adequate access to GPS satellite signals and your emergency response center is equipped to process such information.

You can also use the GPS feature to view your approximate location. Location information appears on the phone's display.

Java applications loaded on your phone can also request your location. If your phone is connected to a laptop computer or similar device, software running on that device can request your location. To protect your privacy, you can control whether these requests are granted.

IMPORTANT: Things to Keep in Mind

If you are using the GPS feature of your phone while driving, please give full attention to driving and to the road.

Where adequate signals from multiple satellites are not available (usually because your GPS antenna cannot establish a view of a wide area of open sky), **the GPS feature of your phone WILL NOT WORK. Such situations include but are not limited to:**

- **In underground locations**
- **Inside of buildings, trains, or other covered vehicles**
- **Under any other metal or concrete roof or structure**
- **Between tall buildings or under dense tree-cover**
- **Near a powerful radio or television tower**

GPS Enabled

- **When your GPS antenna is covered (for example, by your hand or other object) or facing the ground**
- **In temperature extremes outside the operating limits of your phone**

Walking or driving very slowly may also substantially reduce GPS performance.

Even where location information can be calculated in such situations, it may take much longer to do so, and your location estimate may not be as accurate. Therefore, in any 911 call, always report the location to the emergency response center if you can and if you cannot, remain on your phone for as long as the emergency response center instructs you.

Even where adequate signals from multiple satellites are available, your GPS feature will only provide an approximate location, often within 150 feet (45 meters) but sometimes much further from your actual location. Advice on how to improve GPS performance is provided in “Enhancing GPS Performance” on page 84.

While the GPS feature of your phone can be a valuable navigational aid, it does not replace the need for careful navigating and good judgment. **Never rely solely on one device for navigation.** Remember that the accuracy of the location

information and the time needed to obtain it will vary depending on circumstances, particularly the ability to receive signals from adequate numbers of satellites.

On emergency calls, your phone uses assistance information from the phone network to improve the speed and accuracy of your phone’s location calculation: if such assistance information becomes unavailable, it may reduce the speed and accuracy of the location calculation.

The satellites used by the GPS feature of your phone are controlled by the U.S. government and are subject to changes implemented in accordance with the Department of Defense GPS user policy and the Federal Radionavigation Plan. These changes may affect the performance of the GPS feature of your phone.

Making an Emergency Call

Dial 911 to be connected to an emergency response center. If you are on an active call, you must end it before calling 911.

When you make an emergency 911 call, the GPS feature of your phone begins to seek information to calculate your approximate location. **It will take the GPS feature of your phone some time to determine your approximate location.** Even where your phone has good access to sufficient

GPS satellite signals and network assist data, it may take 30 seconds or more to determine the approximate location. This time will increase where there is reduced access to satellite signals. When your approximate location is determined, it is made available to the appropriate emergency response center.

In some cases, your local 911 emergency response center may not be equipped to receive GPS location information. For this reason, and because the GPS location information reported is only approximate or may not be available in your location (see “IMPORTANT: Things to Keep in Mind” on page 81), **always report your location to the 911 operator** you speak to when making an emergency call, if able, just as you would when using a phone without GPS capabilities.

Note: If you are concerned about whether your local 911 emergency response center is equipped to receive GPS location information, contact your local authorities.

In general, if your phone has access to signals from more GPS satellites, your location will be determined faster and more accurately than if your phone has access to signals from fewer GPS satellites.

If your phone does not have adequate access to GPS satellites signals, the location of the nearest cell tower in contact with your phone is automatically made available to the emergency response center, if the center has the capability to receive such information.

See “**Enhancing GPS Performance**” on page 84 for information on how to help your phone determine your location.

Viewing Your Approximate Location

- 1 From the main menu, select **GPS > Position**.
- 2 Scroll to view the entire screen.

This displays the following information about the last time your location was calculated:

- The time (as Greenwich Mean Time) and date that the location was last calculated
- The approximate location, expressed as latitude and longitude
- The estimated accuracy of the calculated location. This estimate of accuracy is only a very rough estimate and may vary substantially from the actual accuracy of the approximate location information reported.

GPS Enabled

- The number of satellites used to calculate the location. In general, more satellites make for better accuracy.

To calculate your location again:

Press  under **Refresh**.

It may take your phone several minutes to complete the process of determining your location. During this time, a message usually appears on your phone's display saying your phone is scanning for satellites. For tips on getting the best location calculation, see "Enhancing GPS Performance".

The **Position** screen displays the updated information.

To cancel a location calculation before it is completed:

Press  under **Cancel** to return to the **Position** screen. **-or-**

Press  to return to the idle screen.

Each time approximate location of your phone is calculated, the latest location information is stored in your phone and remains there even when your phone is powered off. You will see this information the next time you view the **Position** screen.

If you received a phone call or alert while attempting to determine your location, the **Position** screen will disappear, but your phone will continue attempting to determine its location. If it is successful, the new location information will be displayed the next time you view the **Position** screen.

Enhancing GPS Performance

Sometimes the GPS feature of your phone may be unable to complete a location calculation successfully. If this happens when you are making an emergency call, the location of the nearest cell tower in contact with your phone is made available to the appropriate emergency response center if the center has the capability to receive such information. If this happens when you are trying to view your location on the phone's display, you will see a message indicating that your phone cannot access satellites.

Enhancing GPS Performance

To improve accuracy and increase your chances of a successful calculation, do the following while your phone is determining your approximate location:

- Stay in the open. The GPS feature works best where there is nothing between your phone and a large amount of open sky. If possible, go outside, away from tall buildings and foliage. While performance in a building is improved by moving closer to windows, glass with certain sun shielding films may block satellite signals.
- Extend your phone antenna.
- Hold your phone to enhance reception. Signals from GPS satellites are transmitted to your GPS antenna, which is in your phone antenna. Hold your phone away from your body, giving the antenna clear access to satellite signals. Do not cover the antenna area with your fingers or anything else.

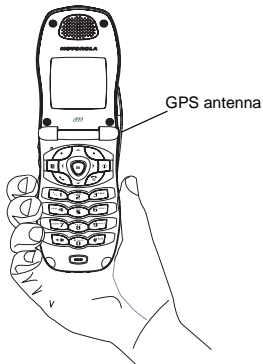

GPS Enabled

- Stand still. If possible, stand still until your phone is finished determining your location. Moving your phone at a walking pace while your phone is calculating your approximate location may substantially decrease GPS performance.
- In a car. When using the GPS Enabled feature in a car, position your phone so that the GPS antenna has good access to GPS signals through the car's windows. Typically, the GPS antenna has best access to GPS signals in a car when placed near a window.

Note: Although moving your phone at a walking pace decreases GPS performance, moving it at the speed of a moving car does not.

- Stay in SouthernLINC Wireless coverage. The SouthernLINC Wireless network will provide your phone with information that helps determine your location more quickly and accurately.

Setting Privacy Options

Your phone's GPS privacy options control whether Java applications on your phone or other software applications may view the location of your phone. You may set your phone to one of these GPS privacy options.

Note: Privacy options do not apply to the transmission of location information during emergency 911 calls.

To set your GPS privacy options:

- 1 From the main menu, select **GPS > Privacy**.
- 2 If your GPS PIN security feature is enabled, enter your GPS PIN. (See "Setting the GPS PIN Security Feature" for more information.)
- 3 Select the privacy option you want:
 - **Restricted** — No Java or similar software applications may view the location of your phone. However, location information may still be available to the phone's owner, fleet manager, or account administrator.
 - **Unrestricted** — All applications may view the location of your phone, without notifying you.
 - **By Permission** — When an application attempts to view the location of your phone, you will be prompted to give permission. However, location information may still be available to the phone's owner, fleet manager, or account administrator.

Setting the GPS PIN Security Feature

To prevent your GPS privacy settings from being altered without your knowledge, your GPS privacy option can be protected by a PIN.

Using GPS with Map Software

You can use the GPS feature of your phone to provide approximate location data to a laptop computer or similar device that is running interactive map software such as that made by DeLorme or Microsoft. This way, if your phone has good access to GPS signals, your approximate position on a map can be made available as you travel in a vehicle.

To do this, connect your phone to your laptop (or other device) with a data cable and set your phone to transmit data (see “Getting Started” on page 88). Your phone then provides your approximate location to the device running the map software, which displays your location on a map. Your phone provides an updated location every second and the map software displays your changing location on its map.

See “**Enhancing GPS Performance**” on page 84 for more details on obtaining good location information.

Note: Because your phone is continuously determining your location, using the GPS feature of your phone with map software uses the phone’s battery power quickly.

When you receive your phone, the GPS security feature is turned off, so you do not have to enter a GPS PIN to access your GPS privacy options. If you turn this feature on, you will be required to enter a GPS PIN to access your GPS privacy options.

To turn the GPS Enabled security feature on or off:

- 1 From the main menu, select **Settings > Security > GPS PIN**.
- 2 Select **On** or **Off**.
- 3 Enter the current GPS PIN.



Note: When you receive your phone, your GPS PIN is 0000.

- 4 Press  under **Ok**.

To change your GPS PIN:

- 1 From the main menu, select **Settings > Security > Change Password > GPS PIN**.
- 2 Enter the current GPS PIN.

Note: When you receive your phone, your GPS PIN is 0000.

- 3 Press  under **Ok**.
- 4 Enter the new 4- to 8-digit GPS PIN.
- 5 Press  under **Ok**.
- 6 Enter the new 4- to 8-digit GPS PIN to confirm.
- 7 Press  under **Ok**.

GPS Enabled

Software Compatibility

Your phone sends location information to your laptop or other device using the standard National Marine Electronics Association (NMEA) format. Your phone supports output messages in NMEA-0183 format and supports the following NMEA-0183 sentences: GGA, GLL, GSA, GSV, RMC, and VTG.

The map software running on your laptop or other device must support NMEA 3.0.

Getting Started

To connect your phone to your laptop or other device:

- 1 Open the connector cover.

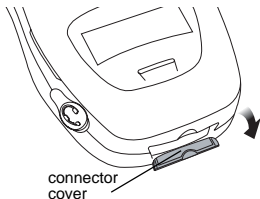

- 2 With the phone's display facing up, insert the data cable's connector into the accessory connector, until you hear a click.

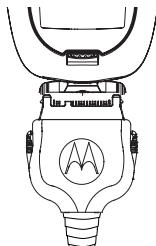

- 3 Insert the data plug into the COM port of your laptop or other device.

Make sure no other application is using the COM port selected.

Make sure the COM port settings of your laptop or other device are set to the following:

- Bits per second: 4800
- Data bits: 8
- Parity: None
- Stop bits: 1

- Flow control: Hardware

To set your phone to send location information to your laptop or other device:

- 1 From the main menu, select **GPS > Interface**.
- 2 Set **NMEA OUT** to **On**.

Your phone is now sending location data to your laptop or other device.

To stop your phone from sending location data to your laptop or other device:

Set **NMEA OUT** to **Off**.

Each time you power your phone on, **NMEA OUT** is automatically set to **Off**.

Voice Records



A voice record is a recording you make with your phone and can play back. You can record notes to yourself or phone calls.

Your phone can store up to 20 voice records.

Creating Voice Records



To record a note to yourself:

- 1 From the main menu, select **VoiceRecord** > **[New VoiceRec]**.
- 2 Say the message you want to record into the microphone.



Tip: To stop recording before you are finished, press  under **Pause**. To start recording again, press  under **Resume**. To stop recording and discard the voice record at any time, press  under **Cancel**.

- 3 When you are finished recording, press .

To add to the end of voice record:

- 1 From the main menu, select **VoiceRecord**.
- 2 Scroll to the voice record you want to add to.
- 3 Press .
- 4 Select **Add To**.
- 5 When you are finished recording, press .

To record a phone call:

- 1 While on an active call, press .
- 2 Select **Record**.
- 3 When you are finished recording, press .

Note: Recording of phone calls is subject to applicable laws regarding privacy and recording of phone conversations.

Playing Voice Records

- 1 From the main menu, select **VoiceRecord**.
- 2 Select the voice record you want to play.
- 3 To stop the voice record while it is playing, press .

Tip: To fast forward, scroll right. To rewind, scroll left. To pause or resume, press any number key.

Labeling Voice Records



When you create a voice record, it is labeled with the time and date it was recorded. You can then rename it with a custom label.

- 1 From the main menu, select **VoiceRecord**.
- 2 Scroll to the voice record you want to label.
- 3 Press  under **Label**.
- 4 Enter the label you want to assign.



- 5 Press .

Deleting Voice Records

To delete a voice record:

- 1 From the main menu, select **VoiceRecord**.
- 2 Scroll to the unlocked voice record you want to delete.
- 3 Press .
- 4 Select **Delete**.
- 5 Press  or  under **Yes** to confirm.

To delete all voice records:

- 1 From the main menu, select **VoiceRecord**.
- 2 Scroll to any voice record.
- 3 Press .
- 4 Select **Delete All**.
- 5 Press  or  under **Yes** to confirm.

Locking Voice Records

When you lock a voice record, it cannot be deleted until you unlock it.



- 1 From the main menu, select **VoiceRecord**.
- 2 Scroll to the voice record you want to lock or unlock.
- 3 Press .

- 4 Select **Lock** to lock the message. **-or-**
Select **Unlock** to unlock the message.



When a voice record is locked, this icon  appears next to it.

Managing Memory

To view the amount of memory available for voice records:

- 1 From the main menu, select **VoiceRecord**.
- 2 With **[New VoiceRec]** highlighted, press  under **Memory**. **-or-**
With any voice record highlighted, press .
Select **Memory**.

To free more memory by deleting all unlocked voice records:

- 1 From the voice records memory screen, press  under **Delete**.
- 2 Press  or  under **Yes** to confirm.

Note: Voice records are stored in your phone using the same memory space used to store messages, Java application data, pictures, ring tones, and wallpaper images. Deleting some of these other items frees memory for voice records.

Customizing Your Phone

Setting the Volume

Of the Earpiece and Speaker

- 1 From the main menu, select **Settings > Volume**.
- 2 Scroll to **Earpiece** to set the earpiece volume.
-or-

Scroll to **Speaker** to set the speaker volume.

- 3 To set the volume:

Scroll left or right. **-or-**

Press the volume controls.

Of the Ringer

Press the volume controls.

Setting Your Phone to Vibrate

To set your phone to vibrate instead of making a sound when you receive phone calls, InstantLINC Mobile to Mobile calls, group calls, message notifications, and call alerts, see “Setting Your Phone to Vibrate” on page 49.

To set your phone to vibrate instead of making a sound when you receive InstantLINC Mobile to Mobile calls, and group calls, even if you want your phone to ring for other features:

- 1 From the main menu, select **Settings > InstantLINC > Alert Type**.

Tip: If **Alert Type** does not appear: From the main menu, select **Ring Tones**. Make sure **VibeAll** is set to **Off**. Repeat step 1.

- 2 Select **Vibrate** to set your phone to vibrate.

Tip: Select **Silent** in step 2 to set your phone to neither vibrate nor make a sound.

Changing the Look of Your Phone

Wallpaper

A wallpaper is an image that appears on the idle screen.

Choosing a Wallpaper

- 1 From the main menu, select **Settings > Display/Info > Wallpaper > Wallpaper**.
- 2 Select the wallpaper you want.



Tip: If you want to see what the wallpaper looks like, press  under **View**.

Setting Wallpaper to Change Automatically

- 1 From the main menu, select **Settings > Display/Info > Wallpaper > Auto Cycle**.
- 2 Select how often you want the wallpaper to change.

Any of the wallpapers in your phone may appear on your idle screen.

Deleting a Wallpaper

- 1 From the main menu, select **Settings > Display/Info > Wallpaper > Wallpaper**.
- 2 Select the wallpaper you want to delete.
- 3 Press .
- 4 Select **Delete**.
- 5 Press .
- 6 Press  under **Yes**.

Setting Text Size

To set the size of the text on the internal display:

- 1 From the main menu, select **Settings > Display/Info > Text Size**.
- 2 Select the option you want:
 - **Zoom** — 11 characters per line
 - **Standard** — 14 characters per line
 - **Compressed** — 18 characters per line

To set your phone to briefly display very large digits when you enter numbers at the idle screen:

- 1 From the main menu, select **Settings > Display/Info > Large Dialing**.
- 2 Set this option to **Large Digits**.

Setting Contrast

To set the contrast of the display:

- 1 From the main menu, select **Settings > Display/Info > Contrast**.
- 2 To set the contrast of the internal display, select **Int. Display**. -or-
To set the contrast of the external display, select **Ext. Display**.
- 3 Scroll left or right to set the contrast.

Setting the Menu View

You can set the items on your main menu and Java applications menu to appear as large icons or a list:

- 1 From the main menu, select **Settings > Display/Info > Menu View**. -or-
From the main menu: Press . Select **Main Menu Setup > Menu View**.
- 2 To choose a list, select **List View**. -or-

Customizing Your Phone

To choose large icons, select **Icon View**.

Setting the Backlight

A backlight lights the display and keypad when you make or receive a call, open or close the flip, or press keys or buttons.

To control how long the backlight stays on:

- 1 From the main menu, select **Settings > Display/Info > Backlight > Backlight**.
- 2 Select the number of seconds you want the backlight to stay on. **-or-**

Select **Off** if you never want the backlight on.

To set the keypad backlight to light up only in low light conditions:

- 1 From the main menu, select **Settings > Display/Info > Backlight > Sensor**.
- 2 Set this option to **On**.

Airplane Mode — Temporarily Turning Off Calls

Sometimes you may want to have your phone on, but turn off its ability to make and receive calls, such as when you are on an airplane.

To set your phone so that it cannot make or receive phone calls, InstantLINC Mobile to Mobile calls, or group calls; or transfer data:

- 1 From the main menu, select **Settings > Advanced > Airplane Mode**.
- 2 Set this option to **On**.

Note: Pressing  for more than 5 seconds also turns on Airplane mode.

This icon  appears.

To restore your phone's ability to do all these things:

Set this option to **Off**.

Using Settings

Settings contains many submenus that let you customize your phone.

For information on applying groups of settings to your phone together, see "Profiles" on page 99.

Display/Info Features

The Display/Info menu controls how the keypad and display appear:

- **Wallpaper** — changes the wallpaper that appears on the idle screen.
- **Palette** — changes the color scheme of the display.
- **Text Size** — sets size of text on the display.
- **Home Icons** — controls whether main menu icons appear on the idle screen.
- **Backlight** — controls backlight illumination.
- **Clock** — controls whether the time and date appear on the idle screen; sets time and date format; sets year.
- **Menu View** — controls whether the items on your main menu and Java applications menu appear as large icons or a list.
- **Large Dialing** — sets large digits to appear on the idle screen when you enter a number.
- **Contrast** — sets the contrast of the display.
- **Language** — sets the language that your phone displays.

Phone Calls Features

The Phone Calls menu controls how your phone handles phone calls:

- **Set Line** — sets phone line 1 or phone line 2 as the active line for outgoing calls.
- **Any Key Ans** — If this feature is on, you can answer calls by pressing any key on the keypad.
- **Auto Redial** — sets your phone to automatically redial calls you make when the system is busy.
- **Call Waiting** — See “Call Waiting” on page 38.
- **Auto Ans** — sets your phone to automatically answer an incoming call after a specified number of rings. When this feature is on, the phone answers by connecting you to the caller; it does not send the call to voice mail, unless you are out of coverage or on the line.
- **Flip Activation** — See “Setting Flip Actions” on page 41.
- **Minute Beep** — causes a beep to sound every minute of an active call.
- **Call Duration** — causes the duration of a call to appear on the display when the call ends.
- **TTY** — See “Making TTY Calls” on page 43.
- **Notifications** — See “Message Notifications” on page 55.

Customizing Your Phone

- **Java App Control** — If you have installed a Java application that answers phone calls, this setting lets you turn that application on.

InstantLINC Mobile to Mobile Features

The InstantLINC Mobile to Mobile menu controls how your phone handles InstantLINC Mobile to Mobile calls and group calls:

- **Tkgrp Silent** — controls whether you hear group calls to your Talkgroup. See “Turning off Group Calls” on page 46.
- **Tkgrp Area** — lets you define your Talkgroup area.
- **One Touch PTT** — See “Setting One Touch PTT” on page 40.
- **Alert Type** — controls how your phone notifies you when you receive InstantLINC Mobile to Mobile calls, and group calls.

Personalize Features

The Personalize menu makes main menu items easier to access.

- **Menu Options — Reorder Menu** lets you change the order of the items on the main menu by grabbing and moving them; **Add/Remove Apps** lets you create a shortcut to a Java application on the main menu.
- **Up Key** — sets the main menu item you access when you scroll up from the idle screen.
- **Down Key** — sets the main menu item you access when you scroll down from the idle screen.
- **Left Key** — sets the main menu item you access when you scroll left from the idle screen.
- **Right Key** — sets the main menu item you access when you scroll right from the idle screen.
- **Center Key** — sets the main menu item you access when you press  from the idle screen.
- **Left Sftkey** — sets the main menu item you access when you press the left option key from the idle screen.
- **Right Sftkey** — sets the main menu item you access when you press the right option key from the idle screen.

- **Power Up** — sets the main menu item you see when you power on your phone. To set the idle screen to be the first thing you see when you power on your phone, select **Default Ready**.

Volume Features

The Volume menu sets the volume of sounds your phone makes:

- **Line 1** — sets ringer volume for phone line 1.
- **Line 2** — sets ringer volume for phone line 2.
- **Messages** — sets the volume of message notifications and Datebook reminders.
- **Earpiece** — sets the volume of sound coming out of the earpiece.
- **Speaker** — sets the volume of sound coming out of the speaker.
- **Keypad** — sets the volume of sound associated with pressing keys and buttons.
- **Java Earpiece** — sets the volume of sound associated with Java applications coming out of the earpiece.
- **Java Speaker** — sets the volume of sound associated with Java applications coming out of the speaker.
- **Data** — sets the volume of sounds that notify you that you are receiving a circuit data call.

Security Features

The Security menu lets you turn security features on and off and change passwords:

- **Phone Lock** — turns on a feature that locks your phone: **Lock Now** takes effect immediately; **Auto Lock** takes effect when your phone is powered off and then on. An unlock code is required to enable this feature, to unlock the phone, and to set a new unlock code. Contact SouthernLINC Wireless for your default unlock code.
- **Keypad Lock** — locks the phone's keypad, either immediately or automatically after a set period of inactivity.
- **SIM PIN** — enables and disables your phone's SIM PIN security feature. See "Turning the PIN Requirement On and Off" on page 13.
- **GPS PIN** — enables and disables your phone's GPS PIN security feature. See "Setting the GPS PIN Security Feature" on page 86.
- **Change Passwords** — changes your phone unlock code, security code, SIM PIN, and GPS PIN.

Advanced Features

The Advanced menu contains advanced and rarely used Settings features.

- **Alert Timeout** — sets the amount of time a tone continues to sound when you receive a message notification, call alert, or Datebook reminder.
- **Headset/Spkr** — sets headset option. See “Using a Headset” on page 105.
- **Disco Lights** — sets the lights in the external display to light up when a musical ring tone sounds.

Note: Some musical ring tones you download to your phone may not activate disco lights.

- **Connectivity** — **Network ID** sets the phone's network IDs and their roaming options under the direction of SouthernLINC Wireless; **Master Reset** lets SouthernLINC Wireless reset your service in the event of a security or provisioning problem.
- **Reset Defaults** — **Reset Settings** returns all settings to their original defaults; **Reset All** returns all settings to their original defaults and erases all stored lists. Use only under the direction of SouthernLINC Wireless.
- **Return to Home** — controls how long the recent calls list displays after calls.

- **Airplane Mode** — prevents your phone from making or receiving phone calls, InstantLINC Mobile to Mobile calls, group calls, or transferring data.
- **Phone Only** — prevents your phone from making or receiving InstantLINC Mobile to Mobile calls, or group calls; or transferring data.
- **Baud Rate** — sets the baud rate at which your phone communicates with a laptop computer, PC, or similar device.

Profiles

A profile is a group of settings saved together so that you can apply them to your phone easily.

A profile contains these settings:

- **Ring Tones** — sets all options described in “Ring Tones” on page 49, except assigning ring tones to Contacts.
- **Display/Info** — sets **Wallpaper**, **Color Palette**, **Text Size**, and **Backlight** options. See “Display/Info Features” on page 95.
- **Phone Calls** — sets **Set Line** and **Auto Ans** options. See “Phone Calls Features” on page 95.
- **Volume** — sets all options described in “Volume Features” on page 97.
- **Call Filter** — controls which calls, call alerts, and message notifications your phone responds to. See “Setting Call Filtering” on page 102.
- **Advanced** — sets headset option. See “Using a Headset” on page 105.

Your phone arrives with pre-set profiles. You can also create your own profiles.

Viewing Profiles

To view the profiles stored in your phone:

- 1 From the main menu, select **Profiles**.
- 2 Scroll to the profile you want to view.

Tip: The profile that is currently in effect on your phone has a checkmark next to it.

- 3 Press  under **View**.
- 4 Scroll to view settings.

Switching Profiles

To apply a profile to your phone:

- 1 From the main menu, select **Profiles**.
- 2 Scroll to the profile you want to apply.
- 3 Press .

The profile you selected is now in effect.

How Changing Settings Affects Profiles

Many of the settings contained in profiles can be set without switching or editing profiles — for example, by selecting **Settings** or **Ring Tones** to set options, or by setting the volume of the phone’s ring using the volume controls.

Profiles

When you do this, your phone either:

- Updates the profile in effect to reflect these changes, without notifying you **-or-**
- Creates a temporary profile that contains these changes

To set your phone to create a temporary profile that contains changes you make to settings:

- 1 From the main menu, select **Profiles**.
- 2 Press .
- 3 Select **Setup > Temp Profile**.
- 4 Set this option to **On**.

To set your phone to update the profile in effect to reflect any changes you make to settings:

Set **Temp Profile** to **Off** in step 4.

Temporary Profiles

If your phone is set to create temporary profiles, a temporary profile is created when you make changes to settings without switching or editing profiles.

A temporary profile is based on the profile in effect when you made the changes, but reflects the changed settings. Making more changes further updates the temporary profile, for as long as it is in effect.

A temporary profile stays in effect until you switch profiles, power off your phone, or delete it (or the profile it is based on) from the list of profiles.

If you do not store a temporary profile, it is deleted when you switch profiles or power off your phone.

A temporary profile is automatically given the same name as the profile it is based on, but with an asterisk (*) in front of it.

When you view a temporary profile's settings, the options that differ from the profile it is based on have an asterisk in front of them.

Storing a Temporary Profile

To store a temporary profile as a new profile:

- 1 From the main menu, select **Profiles**.
- 2 Scroll to the temporary profile.
- 3 Press .
- 4 Select **Store As New**.
- 5 Enter the name you want to give the profile.

When you are finished, press .

To overwrite the profile the temporary profile is based on:

- 1 From the main menu, select **Profiles**.
- 2 Scroll to the temporary profile.
- 3 Press .

4 Select **Store Changes**.

The temporary profile is stored with the name of the profile it is based on. The profile it is based on, as it existed before you made changes to settings, is gone.

Creating Profiles

1 From the main menu, select **Profiles**.

2 Select **[New Profile]**. -or-

Scroll to any profile. Press . Select **New**.

3 Enter the name you want to give the profile.

When you are finished, press .

4 If you want to base this profile on an existing profile: Select **Copy from**. Select the profile you want to base this profile on. If you do not choose a profile to copy from, the new profile is based on a default profile.

5 Press under **Create**.

6 Scroll through the list of options and set their values.

7 Press under **Done**.

Editing Profiles

1 From the main menu, select **Profiles**.

2 Scroll to the profile you want to edit.

3 Press .

4 Select **Edit**.

5 Scroll through the list of options and set their values.

Deleting Profiles

To delete a profile:

1 From the main menu, select **Profiles**.

2 Select the profile you want to delete.

Note: A temporary profile is automatically deleted when the profile it is based on is deleted.

3 Press .

4 Select **Delete**.

5 Press or press under **Yes** to confirm.

To delete all profiles:

1 From the main menu, select **Profiles**.

2 Press .

3 Select **Delete All**.

4 Press or press under **Yes** to confirm.

Setting Call Filtering

The call filtering setting in each profile lets you control which calls, call alerts, and message notifications your phone notifies you of, and which it ignores.

To set call filtering:

- 1 While setting options for a profile, select **Call Filter**.
- 2 To set filtering options for phone calls, select **Phone**.
 - **Off** sets your phone to notify you of all phone calls.
 - **All** sets your phone to ignore all phone calls.
 - **All Contacts** sets your phone to notify you only of phone calls from numbers stored in Contacts.
 - **Some Cntcs** sets your phone to notify you only of phone calls from numbers you select from Contacts.
- 3 If you set the **Phone** option to **Some Cntcs**, select up to 5 Contacts entries that contain phone numbers you want to be notified of calls from.

When you are finished, press  under **Done**.

- 4 To set filtering options for InstantLINC Mobile to Mobile calls and group calls, select **Prvt/Grp**.

- **Off** sets your phone to notify you of all InstantLINC Mobile to Mobile calls and group calls.
 - **On** sets your phone to ignore all InstantLINC Mobile to Mobile calls and group calls.
- 5 To set filtering options for call alerts, select **Alerts**.
 - **Off** sets your phone to notify you of all call alerts.
 - **On** sets your phone to ignore all call alerts.
 - 6 To set filtering options for message notifications, select **Notifications**.
 - **Off** sets your phone to notify you of all messages.
 - **Voice Messages** sets your phone not to sound a tone or vibrate when you receive voice messages.
 - **Text Messages** sets your phone not to sound a tone or vibrate when you receive text messages.
 - **All** sets your phone not to sound a tone or vibrate when you receive any message.
- Note:** When you receive a type of message you have set not to sound a tone or vibrate, the message notification screen appears as usual.
- 7 Press  under **Done**.

Shortcuts



Shortcuts lets you access most menu options by pressing a number on your keypad (1 through 9) or saying the voice name of the shortcut. You create the shortcut and then use it to take you to that screen any time.





Creating a Shortcut

Note: When you receive your phone, all number keys may already be assigned to shortcuts. If this is the case, you can create new shortcuts by deleting or replacing existing shortcuts.

- 1 Go to the menu item you want to create a shortcut for.

For example, if you want to create a shortcut to the screen for creating a new Contacts entry: From the main menu, select **Contacts**, then highlight **[New Contact]**.

- 2 Press and hold  until a confirmation screen appears.
- 3 Press  or press  under **Yes**.
- 4 Select **Key**.
- 5 Press the number key you want to assign to the shortcut.

- 6 Press .
- 7 If you want to record a voice name for the shortcut: Select **Voice**. As directed by the screen prompts, say and repeat the name you want to assign to the number. Speak clearly into the microphone.
- 8 Press  under **Done**.
- 9 If the number key you chose is already assigned to a shortcut, a prompt appears asking if you want to replace the existing shortcut.
Press  under **Yes** to replace the existing shortcut. **-or-**
Press  under **No** if you want to keep the existing shortcut and assign another number key to the shortcut.

Using a Shortcut

If you know the shortcut number:

- 1 From the idle screen, press .
- 2 On your keypad, press the number assigned to the shortcut.

If you do not know the shortcut number:

- 1 From the main menu, select **Shortcuts**.
- 2 Scroll to the shortcut you want to use. **-or-**





Shortcuts

If you assigned a voice name to the shortcut: Press and hold . Say the voice name into your phone. The shortcut with that voice name is then highlighted.

3 Press .

Editing a Shortcut

To change the number assigned to a shortcut:

- 1 From the main menu, select **Shortcuts**.
- 2 With any shortcut highlighted, press .
- 3 Select **Reorder**.
- 4 Scroll to the shortcut you want to move.
- 5 Press  under **Grab**.
- 6 Scroll to the place where you want the shortcut to appear.
- 7 Press  under **Insert**.
- 8 Repeat step 4 through step 7 for all the items you want to move.
- 9 Press  under **Done**.



To change the number or voice name assigned to a shortcut:

- 1 From the main menu, select **Shortcuts**.
- 2 Highlight any shortcut.
- 3 Press  under **Edit**.



4 With **Key** or **Voice** highlighted, press  to change assignments.

Deleting Shortcuts

To delete a shortcut:

- 1 From the main menu, select **Shortcuts**.
- 2 Scroll to the shortcut you want to delete.
- 3 Press .
- 4 Select **Delete**.
- 5 Press  or press  under **Yes** to confirm.

To delete all shortcuts:

- 1 From the main menu, select **Shortcuts**.
- 2 With any shortcut highlighted, press .
- 3 Select **Delete All**.
- 4 Press  or press  under **Yes** to confirm.

Using a Headset

If you use a headset or similar device with your phone, you can set your phone to send incoming sound to the headset only, or to the headset and the speaker at the same time:

- 1 From the main menu, select **Settings > Advanced > Headset/Spkr.**
- 2 Select **HdsetOnly** to send incoming sound to the headset only. **-or-**
Select **Hdset&Spkr** to send incoming sound to the headset and ring tones to the speaker.

Attaching a Headset

- 1 Lift the audio jack cover.
- 2 Insert the headset connector firmly into the audio jack. You may have to rotate the headset connector until it fits securely into the audio jack.

Using a Remote PTT Button

If you are using a headset or other accessory with a remote PTT button, you can use the remote PTT button for phone calls and InstantLINC Mobile to Mobile calls.

For phone calls, use the remote PTT button to answer calls, switch between calls, and end calls. Hold the remote PTT button for less than 2 seconds to answer calls and switch between calls. Hold the remote PTT button for more than 2 seconds to end calls.

Note: For InstantLINC Mobile to Mobile calls, use the remote PTT button as you would the PTT button on your phone. When using a headset, the PTT button on your phone works the same way as when you are not using a headset. Sounds associated with InstantLINC Mobile to Mobile calls and group calls are heard through the headset.

Understanding Status Messages

You may receive status messages under certain conditions. Before contacting SouthernLINC Wireless Customer Care, note the message, numeric code, and the conditions under which it appeared. The following table lists and describes status messages.

Note: When your flip is closed, the internal display screen shows a shortened version of the status message displayed in the external screen. To see complete status messages, open the flip.

Status Messages (external display)	Status Messages (internal display)	Message Description
Number Not in Service	Number Not in Service	The number that you entered is not valid.
Not Avail.	User Not Available	The phone that you called is either busy, out of coverage, or turned off. Please try again later.

Status Messages (external display)	Status Messages (internal display)	Message Description
Not Avail.	User Not Authorized	The person that you called has not purchased this service.
Failed	Please Try Later	This service is temporarily not available. Please try again later.
Restricted	Service Restricted	This service was restricted by SouthernLINC Wireless, or this service was not purchased.
Not Avail.	Service Not Available	You are either out of coverage or having problems with provisioning.
System Busy	System Busy	The system is experiencing heavy traffic. Please try again later.
Failed	Service Conflict	This service cannot be enabled because an incompatible service has already been turned on.

Status Messages (external display)	Status Messages (internal display)	Message Description
Try Again	Please Try Again	An error occurred. Please try again.
	Wrong PIN	You have entered an incorrect PIN number.
	Please Enter Special Code	You have inserted a SIM card that will not work with a SouthernLINC Wireless phone. Contact Customer Care if you believe this is a valid SIM card.
Self Check	Self Check Error + Number Code	A fault was detected with your phone. If this error recurs, note the error code and contact Customer Care.
Self Check	Self Check Fail + Number Code	An operational fault was detected with your phone. Note the numeric code, turn your phone off, and contact Customer Care.

Status Messages (external display)	Status Messages (internal display)	Message Description
PIN Blocked	PIN Blocked Call Your Provider	The incorrect PIN was entered 3 consecutive times. You will be unable to place or receive calls on your phone. Contact Customer Care to have them obtain the PIN Unblocking Key (PUK) code.
Insert SIM	Insert SIM	Your SIM card is not being detected. Please check to ensure that you have inserted the SIM card correctly into your phone.
Enter PIN	Enter SIM PIN	Please enter your 4- to 8- digit SIM PIN code.
Unit Lock	Enter Unlock Code	Auto Phone Lock is activated. Enter your unlock code.
Low Memory	New Browser Message Memory Full!	Warns of low memory for Net Alerts.

Understanding Status Messages

Status Messages (external display)	Status Messages (internal display)	Message Description
	Scanning for Satellites	Searching for GPS satellites.
	Unable to Locate Sats	Could not find GPS satellites.
	Technical Error	A problem occurred in your phone's GPS circuitry. If this error occurs, contact Customer Care.

Safety and General Information

IMPORTANT INFORMATION ON SAFE AND EFFICIENT OPERATION.

READ THIS INFORMATION BEFORE USING YOUR INTEGRATED MULTI-SERVICE PORTABLE RADIO.

RF Operational Characteristics

Your radio product contains a radio frequency transmitter to convey the information you wish to send as well as occasional automatic signals used to sustain connection to the wireless network, and a receiver which enables you to receive communication and connection information from the network.

Portable Radio Product Operation and EME Exposure

Your Motorola radio product is designed to comply with the following national and international standards and guidelines regarding exposure of human beings to radio frequency electromagnetic energy (EME):

- United States Federal Communications Commission, Code of Federal Regulations; 47 CFR part 2 sub-part J.
- American National Standards Institute (ANSI) / Institute of Electrical and Electronics Engineers (IEEE). C95. 1-1992.
- Institute of Electrical and Electronics Engineers (IEEE). C95. 1-1999 Edition.
- International Commission on Non-Ionizing Radiation Protection (ICNIRP) 1998.
- Ministry of Health (Canada). Safety Code 6. Limits of Human Exposure to Radiofrequency Electromagnetic Fields in the Frequency Range from 3 kHz to 300 GHz, 1999.
- Australian Communications Authority Radiocommunications (Electromagnetic Radiation - Human Exposure) Standard 2003.
- ANATEL, Brasil Regulatory Authority, Resolution 303 (July 2, 2002) "Regulation of the limitation of exposure to electrical, magnetic, and electromagnetic fields in the radio frequency range between 9 kHz and 300 GHz." "Attachment to Resolution 303 from July 2, 2002."

Safety and General Information

To assure optimal radio product performance and make sure human exposure to radio frequency electromagnetic energy is within the guidelines set forth in the above standards, always adhere to the following procedures:

Phone Operation

When placing or receiving a phone call, hold your radio product as you would a wireline telephone. **Speak directly into the microphone.**

Two-way radio operation

Your radio product has been designed and tested to comply with national and international standards and guidelines regarding human exposure to RF electromagnetic energy, when operated in the two-way mode (at the face, or at the abdomen when using an audio accessory) at usage factors of up to 50% talk/50% listen.

Transmit no more than the rated duty factor of 50% of the time. To transmit (talk), push the Push-To-Talk (PTT) button. To receive calls, release the PTT button. Transmitting 50% of the time or less, is important because this radio generates measurable RF energy only when transmitting (in terms of measuring for standards compliance).

When using your radio product as a traditional two-way radio, **hold the radio product in a vertical position with the microphone one to two inches (2.5 to 5 cm) away from the lips.**



Body-worn operation

To maintain compliance with FCC RF exposure guidelines, if you wear a radio product on your body when transmitting, always place the radio product in a **Motorola approved clip, holder, holster, case or body harness for this product.** Use of non-Motorola-approved accessories may exceed FCC RF exposure guidelines. **If you do not use a Motorola approved body-worn accessory and are not using the radio product in the intended use positions along side the head in the phone mode or in front of the face in the two-way radio mode, then ensure the antenna and the radio product are kept the following minimum distances from the body when transmitting**

- **Phone or Two-way radio mode: one inch (2.5 cm)**
- **Data operation using any data feature with or without an accessory cable: one inch (2.5 cm)**

ALL MODELS WITH FCC ID AZ489FT5828 MEET THE GOVERNMENT'S REQUIREMENTS FOR EXPOSURE TO RADIO WAVES.

Your wireless phone is a radio transmitter and receiver. It is designed and manufactured not to exceed the emission limits for exposure to radiofrequency (RF) energy set by the Federal Communications Commission of the U.S. Government. These limits are part of comprehensive guidelines and establish permitted levels of RF energy for the general population. The guidelines are based on standards that were developed by independent scientific organizations through periodic and thorough evaluation of scientific studies. The standards include a substantial safety margin designed to assure the safety of all persons, regardless of age and health.

The exposure standard for wireless mobile phones employs a unit of measurement known as the Specific Absorption Rate, or SAR. The SAR limit set by the FCC is 1.6W/kg.¹ Tests for SAR are conducted using standard operating positions reviewed by the FCC with the phone transmitting at its highest certified power level in all tested frequency bands. Although the SAR is determined at the highest certified power level, the actual SAR level of the phone while operating can be well below the maximum value. This is because the phone is designed to operate at multiple power levels so as to use only the power required to reach the network. In general, the closer you are to a wireless base station antenna, the lower the power output.

Before a phone model is available for sale to the public, it must be tested and certified to the FCC that it does not exceed the limit established by the government-adopted requirement for safe exposure. The tests are performed in positions and locations (e.g., at the ear and worn on the

body) as required by the FCC for each model. The highest SAR value for this model phone when tested for use at the ear is 1.41 W/kg and when tested on the body, as described in this user guide, is 1.45 W/kg during packet data transmission. (Body-worn measurements differ among phone models, depending upon available accessories and FCC requirements.)²

While there may be differences between the SAR levels of various phones and at various positions, they all meet the government requirement for safe exposure.

The FCC has granted an Equipment Authorization for this model phone with all reported SAR levels evaluated as in compliance with the FCC RF exposure guidelines. SAR information on this model phone is on file with the FCC and can be found under the Display Grant section of <http://www.fcc.gov/oet/fccid> after searching on FCC ID AZ489FT5828.

Additional information on Specific Absorption Rates (SAR) can be found on the Cellular Telecommunications Industry Association (CTIA) web-site at <http://www.wow-com.com>.

- ¹ In the United States and Canada, the SAR limit for mobile phones used by the public is 1.6 watts/kg (W/kg) averaged over one gram of tissue. The standard incorporates a substantial margin of safety to give additional protection for the public and to account for any variations in measurements.
- ² The SAR information reported to the FCC includes the FCC-accepted Motorola testing protocol, assessment procedure, and measurement uncertainty range for this product.

Safety and General Information

Antenna Care

Use only the supplied or an approved replacement antenna. Unauthorized antennas, modifications, or attachments could damage the radio product and may violate FCC regulations.

DO NOT hold the antenna when the radio product is “IN USE”. Holding the antenna affects call quality and may cause the radio product to operate at a higher power level than needed.

Approved Accessories

For a list of approved Motorola accessories call 1-800-453-0920, or visit our website at www.motorola.com/iden.

Electromagnetic Interference/Compatibility

Note: Nearly every electronic device is susceptible to electromagnetic interference (EMI) if inadequately shielded, designed or otherwise configured for electromagnetic compatibility.

Facilities

To avoid electromagnetic interference and/or compatibility conflicts, turn off your radio product in any facility where posted notices instruct you to do so. Hospitals or health care facilities may be using equipment that is sensitive to external RF energy.

Aircraft

When instructed to do so, turn off your radio product when on board an aircraft. Any use of a radio product must be in accordance with applicable regulations per airline crew instructions.

Implantable Medical Devices

A minimum separation of six (6) inches should be maintained between a handheld wireless phone and an implantable medical device, such as a pacemaker or implantable cardioverter defibrillator, to avoid potential interference with the device. Persons who have such devices:

- Should ALWAYS keep the phone more than six (6) inches from their implantable medical device when the phone is turned ON;
- Should not carry the phone in a breast pocket;
- Should use the ear opposite the implantable medical device to minimize the potential for interference;

- Should turn the phone OFF immediately if there is any reason to suspect that the interference is taking place.
- Should read and follow the directions from the manufacturer of the implantable medical device. If you have any questions about using your wireless phone with such a device, consult your health care provider.

For more information, see www.fcc.cellphones.gov

Use While Driving

Check the laws and regulations on the use of radio products in the area where you drive. Always obey them.

When using the radio product while driving, please:

- Give full attention to driving and to the road.
- Use hands-free operation, if available.
- Pull off the road and park before making or answering a call if driving conditions so require.

Operational Warnings



For Vehicles with an Air Bag

Do not place a portable radio product in the area over the air bag or in the air bag deployment area. Air bags inflate with great force. If a portable radio is placed in the air bag deployment area and the air bag inflates, the radio product may be propelled with great force and cause serious injury to occupants of the vehicle.

Potentially Explosive Atmospheres

Turn off your radio product prior to entering any area with a potentially explosive atmosphere, unless it is a radio product type especially qualified for use in such areas as “Intrinsically Safe” (for example, Factory Mutual, CSA, or UL approved). Do not remove, install, or charge batteries in such areas. Sparks in a potentially explosive atmosphere can cause an explosion or fire resulting in bodily injury or even death.

Note: The areas with potentially explosive atmospheres referred to above include fueling areas such as below decks on boats, fuel or chemical transfer or storage facilities, areas where the air contains chemicals or particles, such

Safety and General Information

as grain, dust or metal powders, and any other area where you would normally be advised to turn off your vehicle engine. Areas with potentially explosive atmospheres are often but not always posted.

Blasting Caps and Areas

To avoid possible interference with blasting operations, turn off your radio product when you are near electrical blasting caps, in a blasting area, or in areas posted: "Turn off two-way radio". Obey all signs and instructions.

For Phones With Music Players

Listening to music at high volumes over extended periods of time may be harmful to a user's hearing. User should take precautions to minimize this risk by moderating volume levels. If you experience ringing or other hearing-related discomfort, lower volume or discontinue use.

Operational Cautions



Batteries

All batteries can cause property damage and/or bodily injury, such as burns if a conductive material such as jewelry, keys, or beaded chains touches exposed terminals. The conductive material may complete an electrical circuit (short circuit) and become quite hot. Exercise care in handling any charged battery, particularly when placing it inside a pocket, purse, or other container with metal objects. To reduce the risk of injury, batteries should not be exposed to fire, disassembled, or crushed.

Cleaning and Drying Considerations

Using a leather carry case may help protect the surfaces and help prevent liquids (e.g., rain) from entering into the interior of the radio product. This product is not water proof, and exposing the unit to liquids may result in permanent damage to the unit.

If your radio product interior gets wet, then do not try to accelerate drying with the use of an oven or a dryer as this will damage the radio product and void the warranty. Instead, do the following:

- 1** Immediately power off the radio product.

Accessory Safety Information

- 2 Remove Battery and SIM card (if so equipped) from radio product.
- 3 Shake excess liquid from radio product.
- 4 Place the radio product and battery in an area that is at room temperature and has good air flow.
- 5 Let the radio product, battery, and SIM card dry for 72 hours before reconnecting the battery and/or powering on the radio product.

If the radio product does not work after following the steps listed above, contact your dealer for servicing information.

Clean the external surfaces of the radio product with a damp cloth, using a mild solution of dishwashing detergent and water. Some household cleaners may contain chemicals that could seriously damage the radio product. Avoid the use of any petroleum-based solvent cleaners. Also, avoid applying liquids directly on the radio product.

Accessory Safety Information

Important: Save these accessory safety instructions.

- Before using any battery or battery charger, read all the instructions for and cautionary markings on (1) the battery, (2) the battery charger, which may include a separate wall-mounted power supply or transformer, and (3) the radio product using the battery.
- Do not expose any battery charger to water, rain, or snow as they are designed for indoor or in-vehicle use only.



Warning: To reduce the risk of injury, charge only the rechargeable batteries described in “Battery” on page 4. Other types of batteries may burst, causing personal injury and damage.

- To reduce the risk of damage to the cord or plug, pull by the plug rather than the cord when you disconnect the battery charger from the power source outlet.
- Do not operate any battery charger with a damaged cord or plug — replace them immediately.
- Battery chargers may become warm during operation, but not hot. If it becomes hot to the touch, unplug it from the power outlet immediately and discontinue its use.

Safety and General Information

- Use of a non-recommended attachment to a battery charger may result in a risk of fire, electric shock, or injury to persons.
- Make sure the battery charger power cord is located so that it will not be stepped on, tripped over, or subjected to damage or stress.
- An extension cord should not be used with any battery charger unless absolutely necessary. Use of an improper extension cord could result in a risk of fire and electric shock. If an extension cord must be used, make sure that:
 - The pins on the plug of the extension cord are the same number, size, and shape as those on the plug of the charger.
 - The extension cord is properly wired and in good electrical condition.
 - The cord size is 18AWG for lengths up to 100 feet and 16AWG for lengths up to 150 feet.
 - Do not operate any battery charger if it has received a sharp blow, has been dropped, or has been damaged in any way; take it to a qualified service technician.
 - Do not disassemble a battery charger; take it to a qualified service technician when service or repair is required. Incorrect reassembly may result in a risk of electric shock or fire.
- Maximum ambient temperature around the power supply or transformer of any battery charger should not exceed 40°C (104°F).
- The output power from the power supply or transformer must not exceed the rating given on the Desktop Dual-Pocket Charger.
- The disconnection from the line voltage is made by unplugging the power supply from the AC receptacle.
- To reduce risk of electric shock, unplug any battery charger from the outlet before attempting any maintenance or cleaning.

For optimum charging performance, turn off the radio product while charging it in any battery charger.

California Perchlorate Label

Some mobile phones use an internal, permanent backup battery on the printed circuit board that may contain very small amounts of perchlorate. In such cases, California law requires the following label:

“Perchlorate Material - special handling may apply. See www.dtsc.ca.gov/hazardouswaste/perchlorate.”

There is no special handling required by consumer.

Hearing Aid Compatibility

A number of Motorola phones have been tested for hearing aid compatibility. When some wireless phones are used with certain hearing aids, users may detect a noise which can interfere with the effectiveness of the hearing aid.

Some hearing aids are more “immune” than others to this interference noise, and phones can also vary in the amount of interference noise they may generate. ANSI standard C63.19 was developed to provide a standardized means of measuring both mobile phone and hearing aids to determine usability rating categories for both.

Ratings have been developed for mobile phones to assist hearing aid users find phones that may be compatible with their hearing aid. Not all phones have been rated for compatibility with hearing aids. Phones that have been rated have a label with the rating(s) located on the box, and at www.motorola.com/iden.

These ratings are not guarantees of compatibility. Results will vary depending on the user's hearing aid and individual type and degree of hearing loss. If a hearing aid is particularly vulnerable to interference, even a phone with a higher rating

may still cause unacceptable noise levels in the hearing aid. Trying out the phone with your hearing aid is the best way to evaluate it for your personal needs.

“M” Rating: Phones rated M3 or M4 meet FCC requirements for hearing aid compatibility and are likely to generate less interference to hearing aids than unrated phones. (M4 is the “better” or higher of the two ratings.) On those models with an extendable antenna, this rating is determined only with the antenna extended.

“T” Rating: Phones rated T3 or T4 meet FCC requirements and are likely to be more usable with a hearing aid's telecoil (“T Switch” or “Telephone Switch”) than unrated phones. (T4 is the “better” or higher of the two ratings.) On those models with a telecoil mode setting, this rating is determined only with the phone so set. For setting instructions, see “Features for the Hearing Impaired” in the section entitled “Advanced Calling Features”. Note that not all hearing aids have telecoils in them.

Hearing aids may also be measured for immunity to interference from wireless phones and may have ratings similar to wireless phones. Ask your hearing healthcare professional for the rating of your hearing aid. Add the rating of your hearing aid and your phone to determine the estimated usability:

- Any combined rating equal to or greater than six offers excellent use.
- Any combined rating equal to five is considered normal use.
- Any combined rating equal to four is considered usable.

Thus, if you use an M3 phone with a M3 hearing aid you will have a combined rating of six for “excellent use.” This methodology applies equally for T ratings.

More information about hearing aid compatibility may be found at: www.motorola.com/accessibility, www.fcc.gov, www.fda.gov, and www.hearingloss.org/learn/cellphonetech.asp

MOTOROLA LIMITED WARRANTY

Note: FOR IDEN SUBSCRIBER PRODUCTS, ACCESSORIES AND SOFTWARE PURCHASED IN THE UNITED STATES OR CANADA

What Does this Warranty Cover?

Subject to the exclusions contained below, Motorola, Inc. warrants its Motorola iDEN Digital Mobile and Portable Handsets ("Products"), Motorola-branded or certified accessories sold for use with these Products ("Accessories") and Motorola software contained on CD-Roms or other tangible media and sold for use with these Products ("Software") to be free from defects in materials and workmanship under normal consumer usage for the period(s) outlined below. **This limited warranty is a consumer's exclusive remedy, and applies as follows to new Products, Accessories and Software purchased by consumers in the United States or Canada, which are accompanied by this written warranty:**

PRODUCTS COVERED

Products as defined above.

Accessories as defined above.

Products or Accessories that are Repaired or Replaced.

Software as defined above. Applies only to physical defects in the media that embodies the copy of the software (e.g. CD-ROM, or floppy disk).

LENGTH OF COVERAGE

One (1) year from the date of purchase by the first consumer purchaser of the product.

One (1) year from the date of purchase by the first consumer purchaser of the product.

The balance of the original warranty or for ninety (90) days from the date returned to the consumer, whichever is longer.

Ninety (90) days from the date of purchase.

What is not covered? (Exclusions)

Normal Wear and Tear. Periodic maintenance, repair and replacement of parts due to normal wear and tear are excluded from coverage.

Ornamental Decorations. Ornamental decorations such as emblems, graphics, rhinestones, jewels, gemstones and their settings, and other decorative elements, are excluded from coverage.

Batteries. Only batteries whose fully charged capacity falls below 80% of their rated capacity and batteries that leak are covered by this limited warranty.

Abuse & Misuse. Defects or damage that result from: (a) improper operation, storage, misuse or abuse, accident or neglect, such as physical damage (cracks, scratches, etc.) to the surface of the product resulting from misuse; (b) contact with liquid, water, rain, extreme humidity or heavy perspiration, sand, dirt or the like, extreme heat, or food; (c) use of the Products or Accessories for commercial purposes or subjecting the Product or Accessory to abnormal usage or conditions; or (d) other acts which are not the fault of Motorola, are excluded from coverage.

Use of Non-Motorola Products and

Accessories. Defects or damage that result from the use of Non-Motorola branded or certified Products, Accessories, Software or other peripheral equipment are excluded from coverage.

Unauthorized Service or Modification. Defects or damages resulting from service, testing, adjustment, installation, maintenance, alteration, including without limitation, software changes, or modification in any way by someone other than Motorola, or its authorized service centers, are excluded from coverage.

Altered Products. Products or Accessories with (a) serial numbers or date tags that have been removed, altered or obliterated; (b) broken seals or that show evidence of tampering; (c) mismatched board serial numbers; or (d) nonconforming or non-Motorola housings, antennas, or parts, are excluded from coverage.

Communication Services. Defects, damages, or the failure of Products, Accessories or Software due to any communication service or signal you may subscribe to or use with the Products, Accessories or Software is excluded from coverage.

MOTOROLA LIMITED WARRANTY

Software Embodied in Physical Media. No warranty is made that the software will meet your requirements or will work in combination with any hardware or software applications provided by third parties, that the operation of the software products will be uninterrupted or error free, or that all defects in the software products will be corrected.

Software NOT Embodied in Physical Media. Software that is not embodied in physical media (e.g. software that is downloaded from the internet), is provided "as is" and without warranty.

Who is covered? This warranty extends only to the first consumer purchaser, and is not transferable.

What will Motorola Do? Motorola, at its option, will at no charge repair, replace or refund the purchase price of any Products, Accessories or Software that does not conform to this warranty. We may use functionally equivalent reconditioned/refurbished/pre-owned or new Products, Accessories or parts. No data, software or applications added to your Product, Accessory or Software, including but not limited to personal contacts, games and ringer tones, will be reinstalled. To avoid losing such data, software and applications please create a back up prior to requesting service.

How to Obtain Warranty Service or Other Information? To obtain service or information, please call:

Motorola iDEN Customer Services
1-800-453-0920 or 954-723-4910

TTY-877-483-2840

Or visit us online at
<http://www.motorola.com/iden/support>

You will receive instructions on how to ship the Products, Accessories or Software, at your expense, to a Motorola Authorized Repair Center. To obtain service, you must include: (a) a copy of your receipt, bill of sale or other comparable proof of purchase; (b) a written description of the problem; (c) the name of your service provider, if applicable; (d) the name and location of the installation facility (if applicable) and, most importantly; (e) your address and telephone number.

What Other Limitations Are There? ANY IMPLIED WARRANTIES, INCLUDING WITHOUT LIMITATION THE IMPLIED WARRANTIES OF MERCHANTABILITY AND FITNESS FOR A PARTICULAR PURPOSE, SHALL BE LIMITED TO THE DURATION OF THIS LIMITED WARRANTY, OTHERWISE THE REPAIR, REPLACEMENT, OR REFUND AS PROVIDED UNDER THIS EXPRESS LIMITED WARRANTY IS

THE EXCLUSIVE REMEDY OF THE CONSUMER, AND IS PROVIDED IN LIEU OF ALL OTHER WARRANTIES, EXPRESS OR IMPLIED. IN NO EVENT SHALL MOTOROLA BE LIABLE, WHETHER IN CONTRACT OR TORT (INCLUDING NEGLIGENCE) FOR DAMAGES IN EXCESS OF THE PURCHASE PRICE OF THE PRODUCT, ACCESSORY OR SOFTWARE, OR FOR ANY INDIRECT, INCIDENTAL, SPECIAL OR CONSEQUENTIAL DAMAGES OF ANY KIND, OR LOSS OF REVENUE OR PROFITS, LOSS OF BUSINESS, LOSS OF INFORMATION OR DATA, SOFTWARE OR APPLICATIONS OR OTHER FINANCIAL LOSS ARISING OUT OF OR IN CONNECTION WITH THE ABILITY OR INABILITY TO USE THE PRODUCTS, ACCESSORIES OR SOFTWARE TO THE FULL EXTENT THESE DAMAGES MAY BE DISCLAIMED BY LAW.

Some states and jurisdictions do not allow the limitation or exclusion of incidental or consequential damages, or limitation on the length of an implied warranty, so the above limitations or exclusions may not apply to you. This warranty gives you specific legal rights, and you may also have other rights that vary from state to state or from one jurisdiction to another.

Laws in the United States and other countries preserve for Motorola certain exclusive rights for copyrighted Motorola software such as the exclusive rights to reproduce and distribute copies of the Motorola software. Motorola software may only be copied into, used in, and redistributed with, the Products associated with such Motorola software. No other use, including without limitation disassembly of such Motorola software or exercise of the exclusive rights reserved for Motorola, is permitted.

Patent and Trademark Information

MOTOROLA, the Stylized M Logo and all other trademarks indicated as such herein are trademarks of Motorola, Inc. ® Reg. U.S. Pat. & Tm. Off. © 2007 Motorola, Inc. All rights reserved.

Microsoft and Microsoft Internet Explorer are registered trademarks of Microsoft Corporation.

T9 is a trademark owned by Tegic Communications.

T9® Text Input Patent and Trademark Information

This product is covered by U.S. Pat. 5,818,437, U.S. Pat. 5,953,541, U.S. Pat. 6,011,554 and other patents pending.

Java and all other Java-based marks are trademarks or registered trademarks of Sun Microsystems, Inc. in the U.S. and other countries.

All other product names or services mentioned in this manual are the property of their respective trademark owners.

Index

Numerics

3-way calling **39**

A

Accessories **16**

safety **115**

Airplane mode

power button **7**

status icon **11**

turning on and off **94**

Alpha mode **52**

Antenna **15**

B

Backlight **94, 95**

Battery

care **6**

charging **5, 6**

door **3**

inserting **4**

safety **114**

Baud rate **98**

C

Call alerts **23**

deleting **24**

queue **23**

receiving **23**

responding **23, 24**

sending **23**

sorting **24**

viewing **24**

Call filtering **102**

Call forwarding **36**

all calls **36**

missed calls **37**

off **36**

Call Timers **41**

Call Waiting **38**

off **38**

Calls

3-way **39**

answering automatically **95**

answering with any key **18, 95**

emergency **22**

ending **18**

entering number **18**

from Contacts **19**

from Datebook **20**

from memo **48**

from Recent calls **19**

from recent calls **28**

group, see Group calls

InstantLINC Mobile to Mobile
calls **17, 21, 96**

making **17**

on hold **39**

phone calls **17**

receiving **18**

redialing **20, 95**

remote PTT **105**

Speed Dial **20**

TTY, see TTY calls

Turbo Dial **20**

voice name **20**

Circuit data **43**

Clock **95**

Contact information

LINC View **65**

receiving **26, 66**

Index

- sending **65**
- Contacts **19, 30**
 - capacity **34**
 - creating entries **32**
 - deleting **34**
 - icons **30**
 - iDEN Phonebook Manager **35**
 - international numbers **35**
 - searching **31**
 - showing all entries **31**
 - showing only LINC IDs **31**
 - SIM card **30**
 - storing from idle screen **33**
 - storing from Memo **48**
 - storing from recent calls **27**
 - type **30**
 - viewing **31**
 - voice name **33**
 - with non-i833 phones **35**

D

- Datebook **20**
 - profiles **71**
- Display

- backlight **94, 95**
- contrast **93, 95**
- options **9**
- screen **9**
- Drafts **61**
 - see also text messages, drafts

E

- Email **30, 32, 43**
- Emergency calls **22**
- End key **2**

F

- Faxes
 - receiving **43**
 - sending **43**
- Flip action **17, 18, 41**

G

- GPS Enabled **81**
 - best results **84**
 - emergency calls **22, 82**
 - map software **87**
 - privacy options **86**
 - security **86**

- viewing location **83**
- GPS PIN **97**
- GPS, see GPS Enabled
- Group calls **46, 96**
 - making **46**
 - off **46**
 - receiving **46**

H

- Handset, see phone
- Headset **105**
- Hearing Aid Compatibility **118**

I

- Icons
 - Contacts **30**
 - status **11**
 - text entry **52**
- iDEN Phonebook Manager **35**
- Idle screen **9**
 - creating text messages **60**
 - storing to Contacts **33**
- InstantLINC Mobile to Mobile **17, 21, 96**
- International numbers

storing **35**

J

Java applications

deleting **76**

memory **77, 91**

K

Keypad **2**

locking **97**

L

Language **95**

LINC View **65**

LINC View Contact **65**

LINC View My Info **65**

Lists, see menus

M

Memo **48**

calling from **48**

creating **48**

editing **48**

storing to Contacts **48**

viewing **48**

Memory

Java applications **77, 91**

ring tones **51**

text messages **62**

voice records **91**

Menu key **2, 10**

Menus **9**

context-sensitive **2, 10**

main menu **10**

Message center **55, 57**

see also messages

text messages **59**

Message notifications **55**

setting options **55**

Messages **55**

see also voice mail and text
messages

receiving **55**

Mute **21**

My Info **63**

editing **63**

LINC View **65**

receiving **25, 66**

sending **64, 65**

viewing **63**

N

Navigation key **2**

Numeric mode **54**

O

Over-the-air programming **8**

P

Packet data **43**

Passwords **97**

Patent information **vii, 124**

Pauses

dialing **40**

storing **34**

Phone **1, 9**

active line **95**

flip action **17, 18, 41**

locking **97**

modem **42**

off **7**

on **7**

only **98**

setting up **2**

Profiles **99**

call filtering **102**

Index

- changing settings **99**
- creating **101**
- Datebook **71**
- deleting **101**
- editing **101**
- switching **99**
- temporary **100**
- viewing **99**
- Programming, over-the-air **8**
- PTT
 - One Touch **21**
 - One Touch, setting **40**
- PUK code **13**
- Q**
- Quick notes **60**
 - see also text messages, Quick notes
- R**
- Radio frequency **109**
- Recent calls **19, 25, 28**
 - call alerts **25**
 - contact information **26**
 - creating text messages **60**
 - deleting **27**
 - display time **98**
 - storing to Contacts **27**
 - viewing **26**
- Redialing **20, 95**
- Ring tones **30, 49**
 - deleting **51**
 - downloading **51**
 - memory **51**
 - off **49**
 - setting **49**
 - setting in Contacts **32, 50**
 - vibrate **49**
 - viewing assigned **50**
- Ringer **92**
 - see also Ring tones
 - off **92**
- S**
- Safety **109**
 - accessory **115**
 - battery **114**
 - electromagnetic interference **112**
 - implantable medical devices **112**
 - radio frequency **109**
- Security **97**
- Service, activating **7**
- Settings **94**
 - resetting **98**
- Shortcuts
 - creating **103**
 - deleting **104**
 - editing **104**
 - using **103**
- SIM card **3, 12, 14**
 - Contacts **30**
 - inserting **14**
 - with non-i833 phones **35**
- SIM PIN **12, 97**
 - changing **12**
 - default **12**
 - entering **12**
 - requirement **13**
 - unblocking **13**
- Speakerphone **21**
- Speed Dial **20, 31, 33**
- Status messages **106**
- Symbols mode **54**

- T**
- T9 Text Input, see text entry
 - Talkgroups **46, 96**
 - joining **46**
 - Text display area **9**
 - Text entry **52**
 - Alpha mode **52**
 - database **52, 53**
 - icons **52**
 - mode **52**
 - Numeric mode **54**
 - Symbols mode **54**
 - Word mode **52**
 - Text messages **55, 58**
 - creating **59**
 - deleting **61, 62**
 - drafts **61**
 - memory **62**
 - message center **59**
 - receiving **58**
 - sending **59**
 - sent messages **61**
 - setting up **58**
 - sorting **62**
 - text messages
 - quick notes **60**
 - Trademark information **vii, 124**
 - TTY calls **43**
 - baud rate **44**
 - making **43**
 - mode **44**
 - on **44**
 - Turbo Dial **20**
- V**
- Voice mail **55, 57**
 - receiving **57**
 - sending calls to **18, 57**
 - setting up **37, 57**
 - Voice name **20, 31**
 - creating **33**
 - Voice records **90**
 - creating **90**
 - deleting **91**
 - labelling **90**
 - locking **91**
 - memory **91**
 - playing **90**
 - Volume, setting **92, 97**
- W**
- Waits
 - dialing **40**
 - storing **34**
 - Word mode **52**